



katalog náhradních dílů
automatického kotle

VERNER
A302

VERNER SK s.r.o
Klincová 37/b
821 08 Bratislava
SLOVENSKÁ REPUBLIKA
e-mail: kotle-verner@email.cz

PONAST spol. s r.o
Na Potůčkách 163
757 01 Valašské Meziříčí
ČESKÁ REPUBLIKA
tel.: 571 688111*
e-mail: ponast@ponast.cz

aktualizace: 22/11/2022





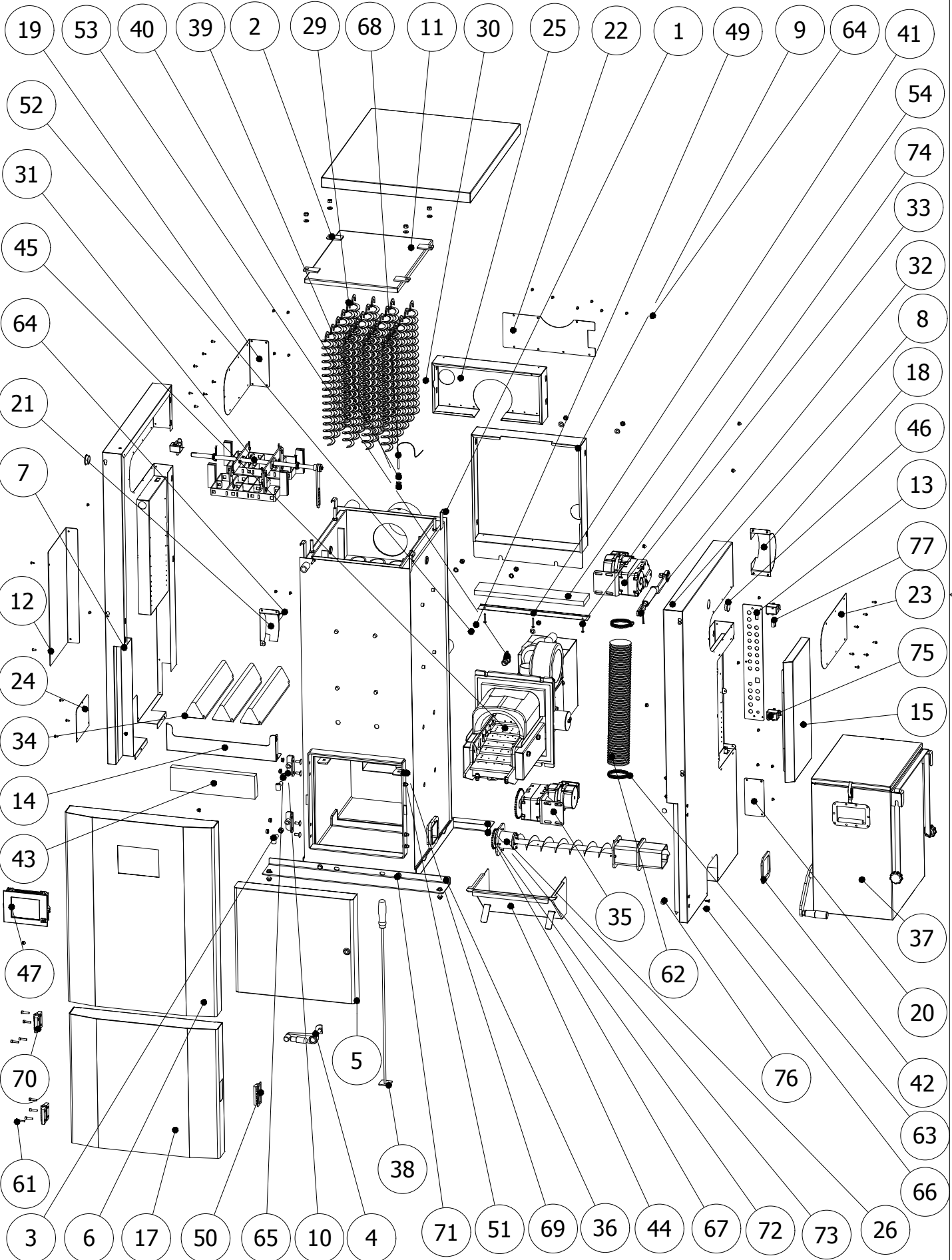

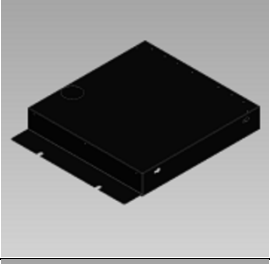

KOTEL A302

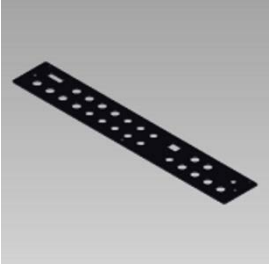

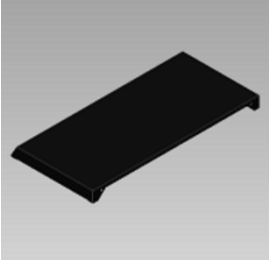
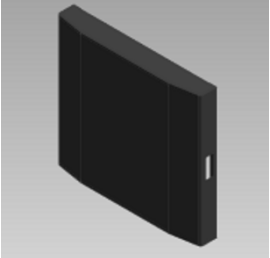
KOTEL A302	POZICE	POPIS	KÓD	ČÍSLO SOUČÁSTI	POČET KS	POZNÁMKY
	1	TĚLESO KOTLOVÉ	PKXX2201	397.S01.000.A1	1	Sestava
	2	VÍKO KOTL.TĚLESA	KKTX0007	002.S02.000.A2	1	Sestava
	3	PANT DVÍŘEK	PKTX0121	054.S05.S03.A4	2	
	4	KLIKA x2	KKTX0019	338.S04.000.A3	1	Sestava
	5	DVÍŘKA	KKTD0029	397.S05.000.A2	1	Sestava
	6	ČELO A302	PKMC0395	913.S03.000.A3	1	SE ZÁMKY

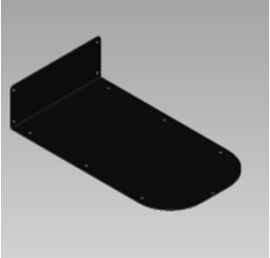

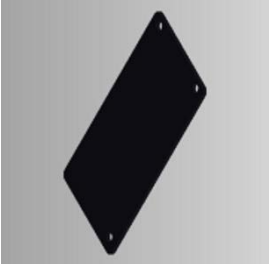
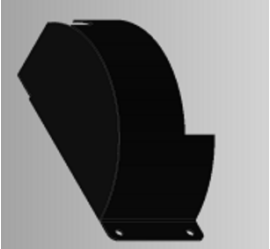
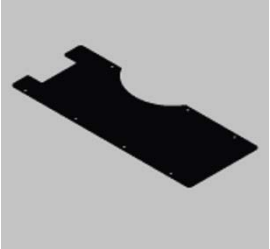
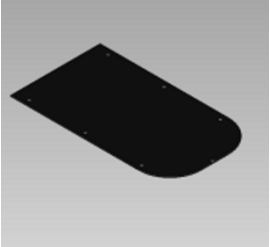
KOTEL A302	POZICE	POPIS	KÓD	ČÍSLO SOUČÁSTI	POČET KS	POZNÁMKY
	7	BOČNICE LEVÁ	PKMD0385 PKMD0126	726.S01.000.A3	1	SE ZÁMKY S PANTY
	8	BOČNICE PRAVÁ	PKMD0386 PKMD0132	726.S02.000.A3	1	SE ZÁMKY S PANTY
	9	KRYT ZADNÍ SPODNÍ	PKMD0093	397.S10.002.A3	1	
	10	PANT DÍL 2	PKTX0134	397.S01.S43.A3	2	
	11	VÍKO HORNÍ- SVAŘENEC	PKMC0151	727.S05.000.A4	1	
	12	KRYT KRABICE	PKMD0168	723.008.000.A3	1	

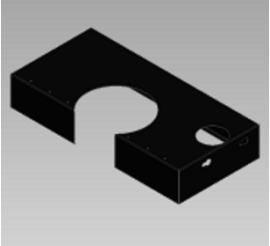
KOTEL A302	POZICE	POPIS	KÓD	ČÍSLO SOUČÁSTI	POČET KS	POZNÁMKY
	13	DESKA	PKMD0143	723.005.000.A4	1	
	14	VZPĚRA	PKMD0359 PKMD0153	727.SA6.000.A4 727.006.000.A4	1	PEVNÉ OTVÍRACÍ
	15	KRYT JEDNOTKY BOČNÍ	PKMD0142	726.008.000.A3	1	
	17	KRYT DVEŘÍ	PKMC0149	727.S04.000.A3	1	
	18	KRYT ČISTĚNÍ	PKMD0081	397.S13.000.A3	1	
	19	KRYTKA POHONU ČISTĚNÍ 2	PKMD0073	397.S07.008.A3	1	

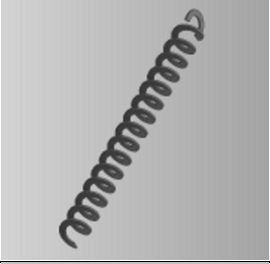
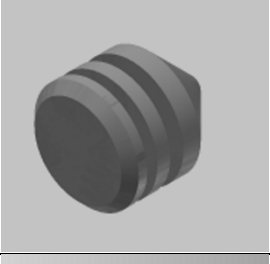
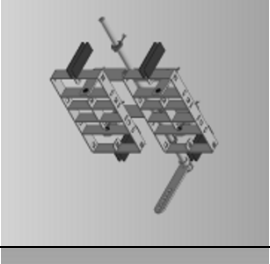
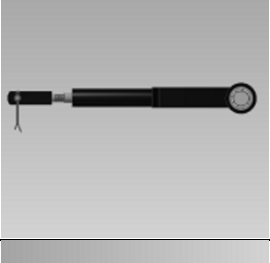
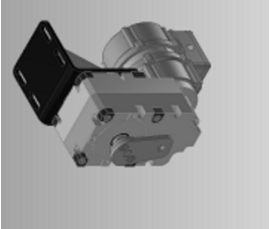

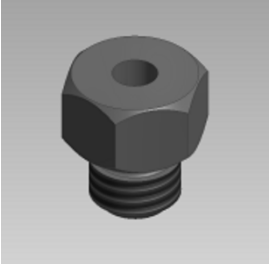

KOTEL A302	POZICE	POPIS	KÓD	ČÍSLO SOUČÁSTI	POČET KS	POZNÁMKY
	20	PLECH KRYCÍ	PKMD0074	397.S07.009.A4	1	
	21	KRYT VYMETÁNÍ L+P	PKMD0062 PKMD0083	397.S14.000.A3	1	PRAVÝ LEVÝ
	22	ZAPLÁTOVÁNÍ	PKMD0089	397.015.000.A3	1	
	23	KRYTKA POHONU ČISTĚNÍ	PKMD0071	397.S07.006.A3	1	
	24	KRYTKA POHONU VYMETÁNÍ 1	PKMD0105	338.S06.005.A3	1	
	25	KRYT ZADNÍ HORNÍ	PKMD0094	397.S10.001.A3	1	

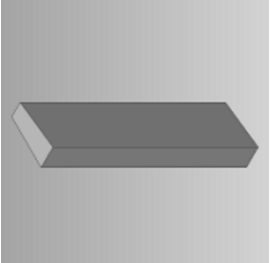
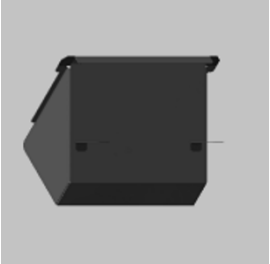
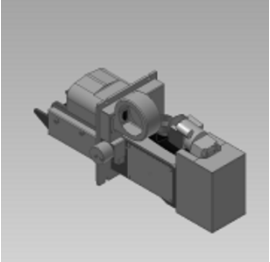



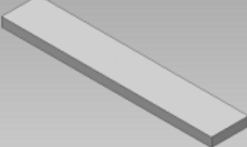
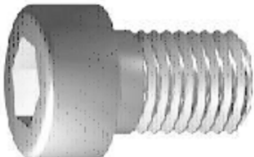
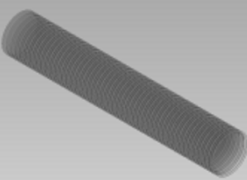

KOTEL A302	POZICE	POPIS	KÓD	ČÍSLO SOUČÁSTI	POČET KS	POZNÁMKY
	26	VYMET.POPELE	KKTX0032	398.000.000.A3	1	Sestava
	29	TURBULÁTOR PLOCHÝ 460mm	MRUZ0016	054.016.000.A4	24	
	30	KLÍČ	PKRX0008	286.000.000.A4	16	
	31	ČISTĚNÍ VÝMĚNÍKU	KKTX0063	796.000.000.A3	1	Sestava
	32	MECHANISMUS ČISTĚNÍ	KKTX0024	424.000.000.A3	1	Sestava
	33	POHON ČISTĚNÍ TAHŮ	KKTX0041	727.S25.000.A3	1	Sestava

KOTEL A302	POZICE	POPIS	KÓD	ČÍSLO SOUČÁSTI	POČET KS	POZNÁMKY
	34	KERAMIKA TROJÚHELNÍKOVÁ	MTKE0135	420.900.000.A3	3	
	35	POHON VYMETÁNÍ	KKTX0039	727.S24.000.A3	1	Sestava
	36	DRŽÁK KOTLE	PKRX0006	005.017.000.A3	2	
	37	POPELNICE 80L	KKTL0041 KKTL0039	448.000.000.A3	1	Sestava PRAVÁ LEVÁ
	38	ŠKRABKA	PKRX0001	001.S32.000.A4	1	
	39	REDUKCE DÍL 1	PKRX0062	792.001.000.A4	1	

KOTEL A302	POZICE	POPIS	KÓD	ČÍSLO SOUČÁSTI	POČET KS	POZNÁMKY
	40	REDUKCE DÍL 2	PKRX0063	792.002.000.A4	1	
	41	DRŽÁK SIBRALU	PKMD0095	397.058.000.A4	1	
	42	TĚSNĚNÍ	PKTX0157	334.S08.005.A4	1	
	43	KERAMIKA NAD DVÍŘKA KP21	MTKE0006	054.021.000.A4	1	
	44	LOPATKA	PKTX0222	398.S09.000.A3	1	
	45	HOŘÁK S POSUVNÝM ROŠTEM 30KW	KVHXX3000	886.000.000.A2	1	Sestava

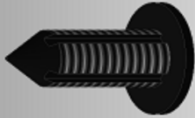
KOTEL A302	POZICE	POPIS	KÓD	ČÍSLO SOUČÁSTI	POČET KS	POZNÁMKY
	46	ZÁSLEPKA ČERNÁ 35-38mm	MRUZ0228		2	
	47	TERMINÁL DOTYKOVÝ HZS 555-S	METR0073		1	
	48	Šrouby samořezné - ST 4,8 x 13	MSSX0118	ISO 7049	47	
	49	Šestihránné matice - M10	MSMX0041	ISO 4032	10	
	50	Rukojeť EPR_90_Pf_C1	MRUZ0205		1	
	51	Ploché podložky - 8	MSPX0001	ISO 7089	24	

KOTEL A302	POZICE	POPIS	KÓD	ČÍSLO SOUČÁSTI	POČET KS	POZNÁMKY
	52	Ploché podložky - 10	MSPX0005	ISO 7089	8	
	53	VENTIL VYPOŠTĚCÍ S PÁČKOU	MRUZ0024		1	
	54	SIBREX 300 20x80x452	MTIZ0019		1	
	61	Šroub s válcovou hlavou - M6 x 16	MSSX0224	DIN 912	8	
	62	HADICE FLEXADUR PU-1NO DN 80x1000	MRUZ0018		1	
	63	SPONA HADICOVÁ 70-90 NEREZ	MRUZ0089		2	

KOTEL A302	POZICE	POPIS	KÓD	ČÍSLO SOUČÁSTI	POČET KS	POZNÁMKY
	64	Vějířová pojistná podložka - A 10,5	MSPX0003	DIN 6798	2	
	65	Šestihranné matice - M12	MSMX0007	ISO 4032	2	
	66	Nýt zarážecí pr.5mm 27024050	MSSX0125		4	
	67	Šestihranné matice - M8	MSMX0016	ISO 4032	28	
	68	Snímač teploty TR 050J-x TCK, 1,4m	METRO108		1	
	69	Šroub vratový - M8 x 20	MSSX0024	ISO 8678	8	

KOTEL A302	POZICE	POPIS	KÓD	ČÍSLO SOUČÁSTI	POČET KS	POZNÁMKY
	70	Pant ELESA CFA.65-SL-H-V	PKTX0295		2	
	71	Šestihranný šroub - M8 x 20	MSSX0002	DIN 933	4	
	72	Šestihranný šroub - M8 x 40	MSSX0027	DIN 933	4	
	73	Podložka - A 10,5	MSPX0005	DIN 125	12	
	74	Šroub do plechu - ST4,8 x 38	MSSX0042	ISO 7049	3	
	75	HAVARIJNÍ TERMOSTAT	METRO049 METRO277		1 1	hořák kotl. těleso

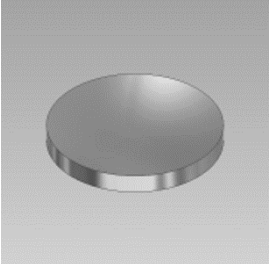
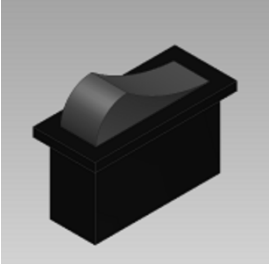
KOTEL A302	POZICE	POPIS	KÓD	ČÍSLO SOUČÁSTI	POČET KS	POZNÁMKY
	76	MAGNET 18x2	MRUZ0077		2	
	77	Vypínač SSk 315 RED	MERX0579		1	

TĚLESO KOTLOVÉ

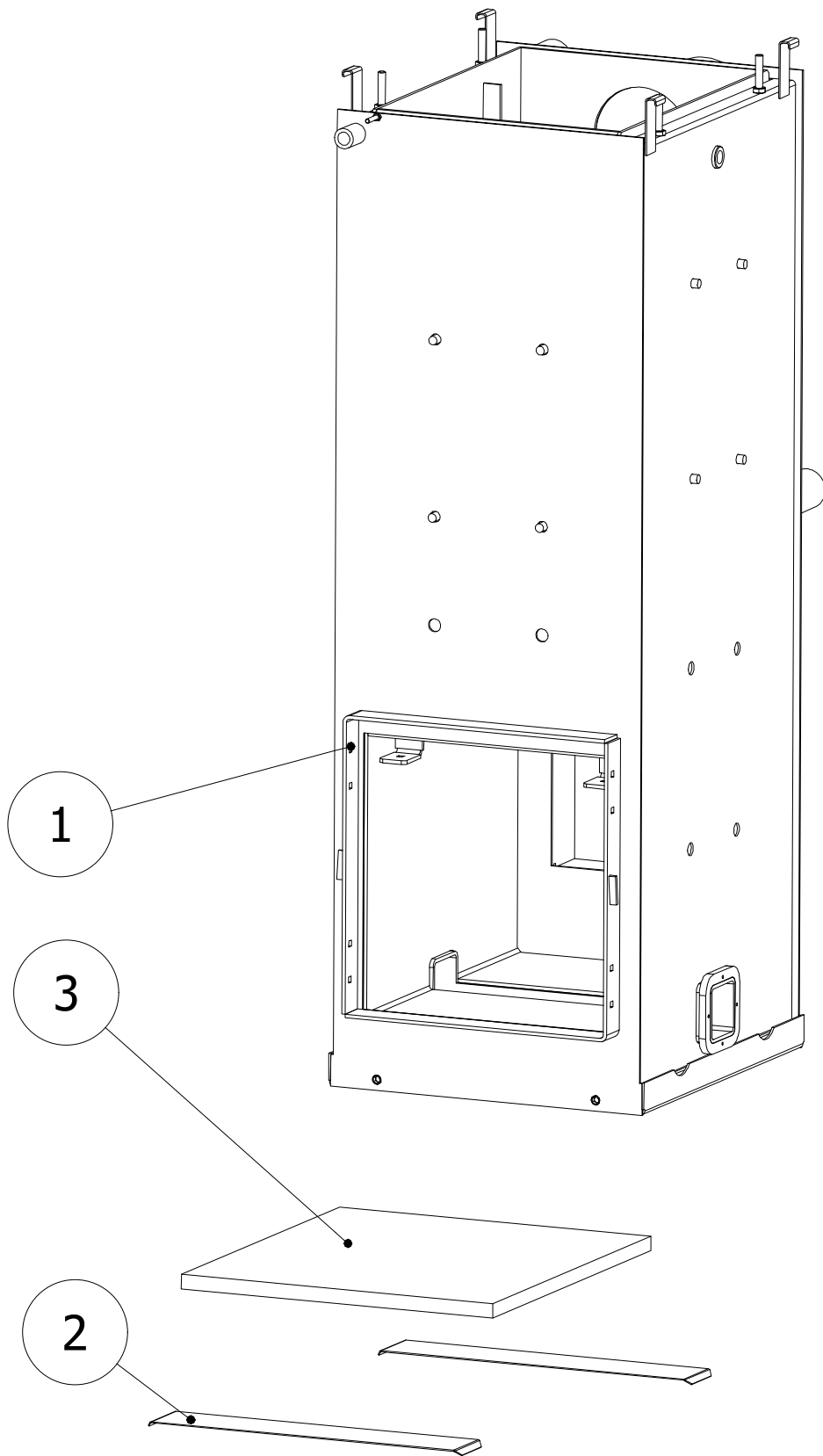

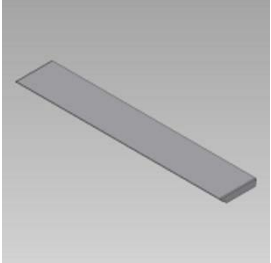
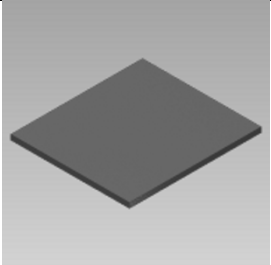
TĚLESO KOTLOVÉ	POZICE	POPIS	KÓD	ČÍSLO SOUČÁSTI	POČET KS	POZNÁMKY
	1	TĚLESO KOTLOVÉ	PKXX2201	397.S01.000.A1	1	
	2	DRŽÁK IZOLACE	PKTX0347	PKTX0347	2	
	3	IZOLACE 20x515x464	PKTX0343		1	

VÍKO

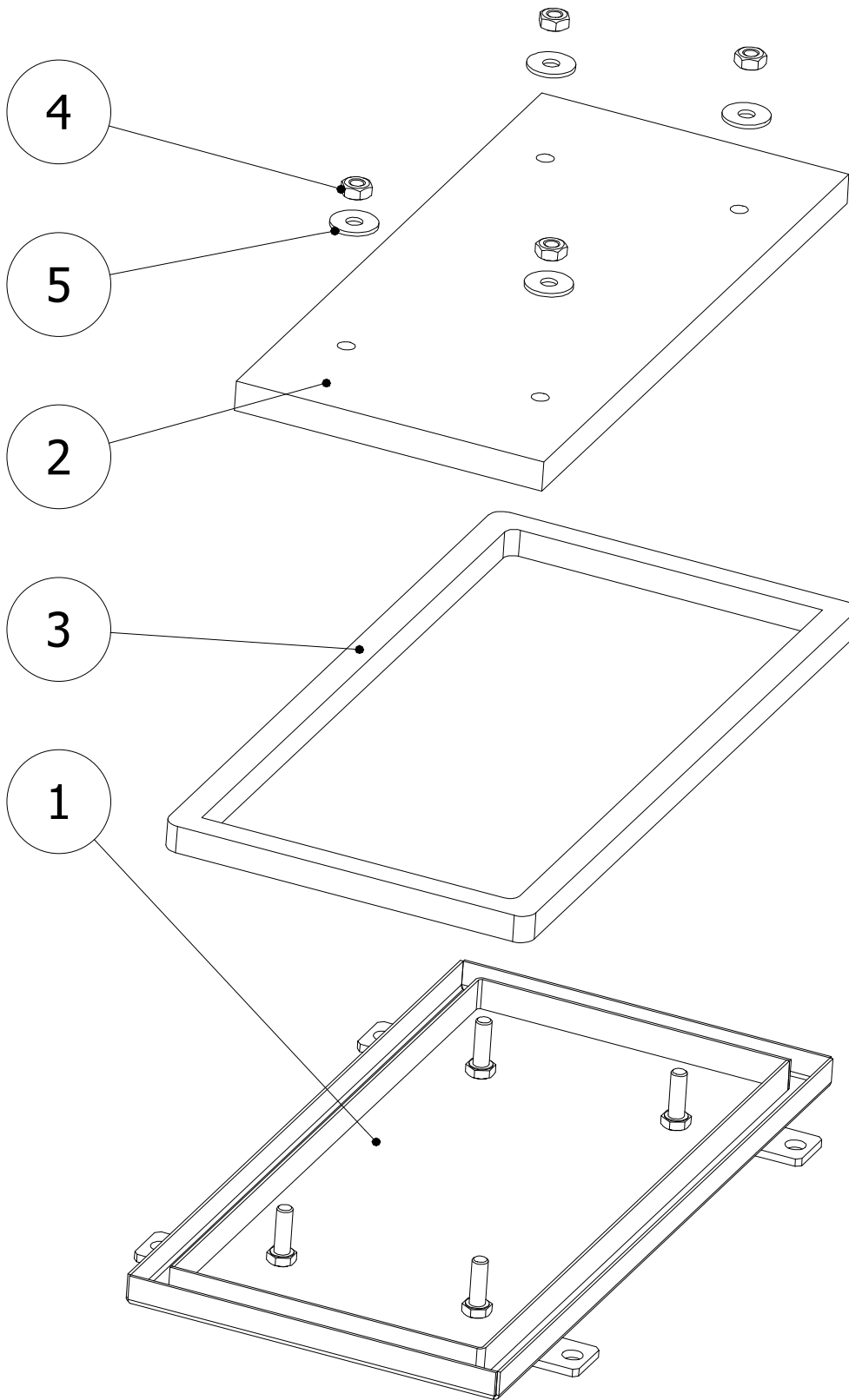

VÍKO	POZICE	POPIS	KÓD	ČÍSLO SOUČÁSTI	POČET KS	POZNÁMKY
	1	VÍKO KOTL.TĚLES A	PKTX0026	002.002.000.A 2	1	
	2	SIBREX 140 20x208x446	MTIZ0006		1	
	3	ŠŇŮRA TĚSNÍCÍ 18x18	MRUZ0133		1.4m	
	4	Šestihránná matice - M10	MSMX0002	DIN 934	4	
	5	Podložka - 10,5	MSPX0004	DIN 9021	4	



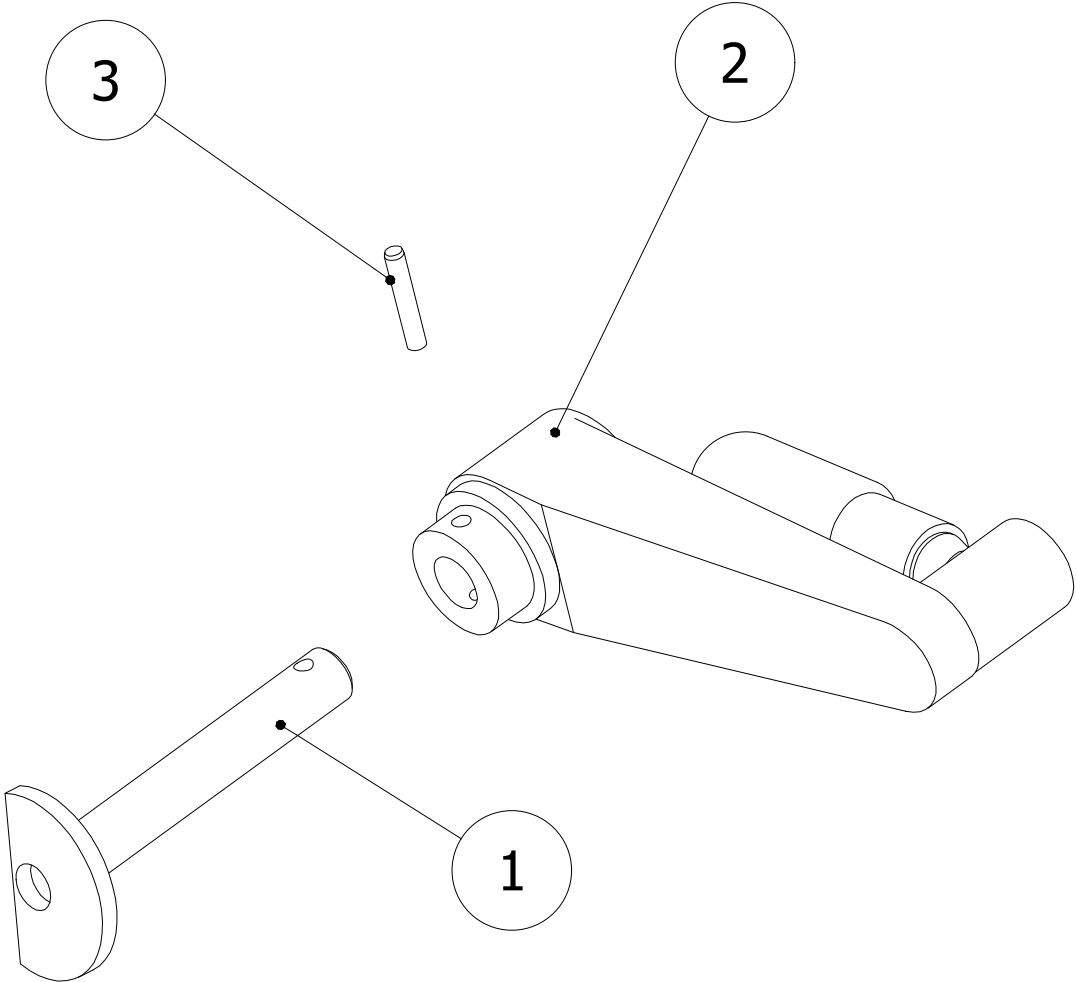

KLIKA



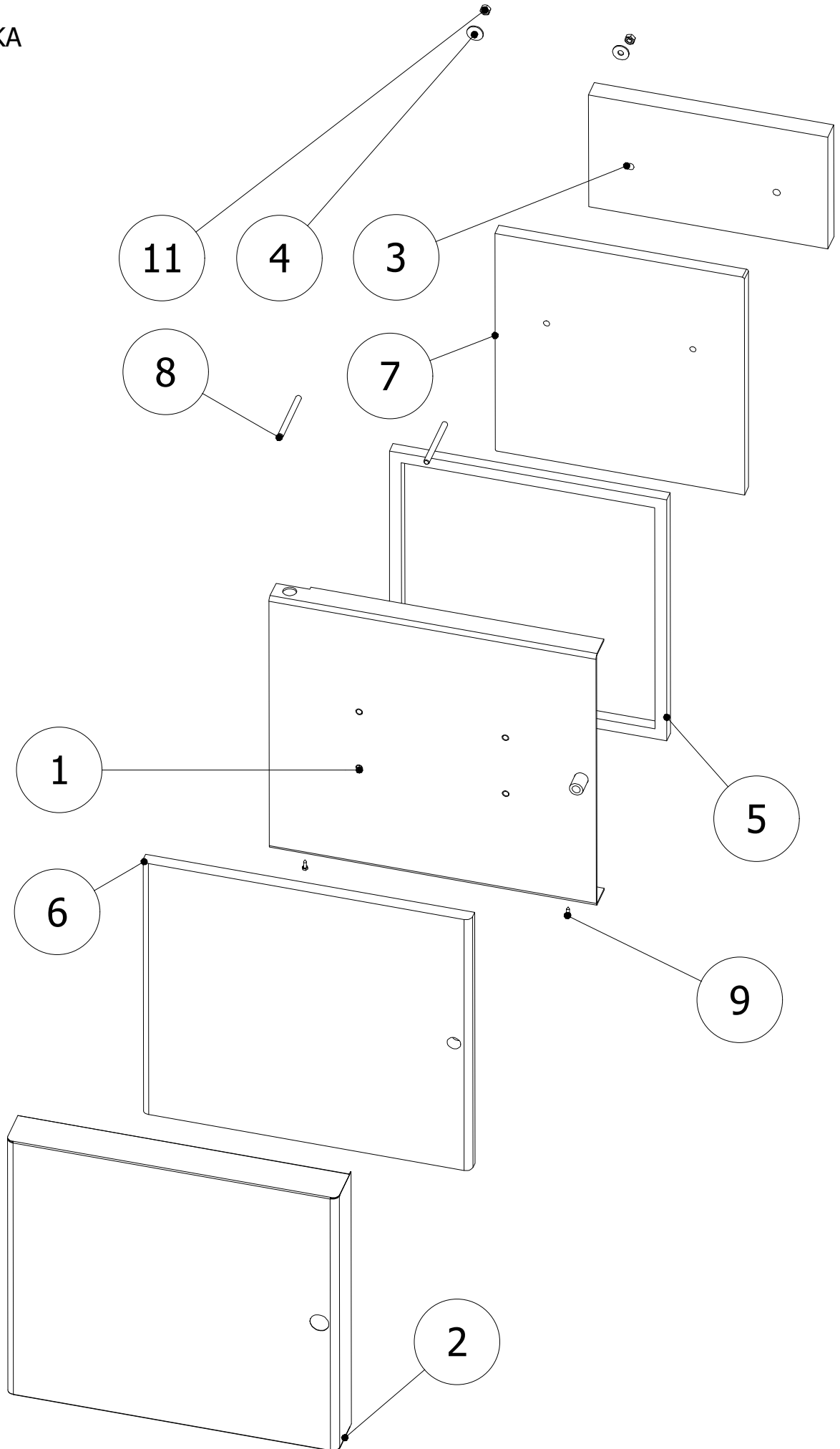

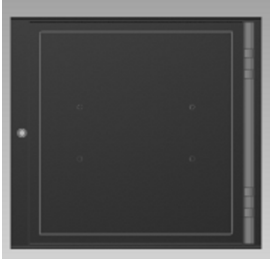
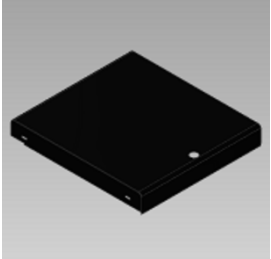
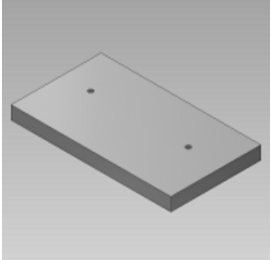
KLIKA	POZICE	POPIS	KÓD	ČÍSLO SOUČÁSTI	POČET KS	POZNÁMKY
	1	DŘÍK KLIKY	PKTX0118	054.S04.001.A3	1	
	2	KLIKA SKLAPOVACÍ ELESA GANTER	MRUZ0117	MT.100-AT+IR	1	KÓD 44317
	3	Kolík - 4 x 24 - A (kalený)	MSRX0003	ISO 8734	1	

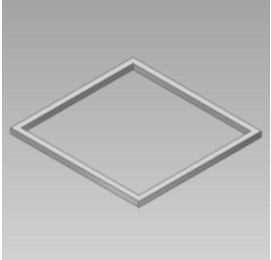
DVÍŘKA

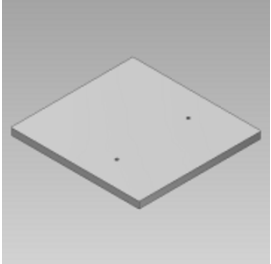
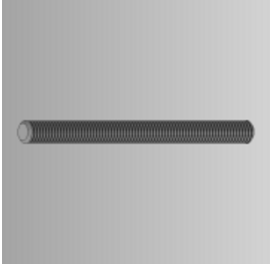
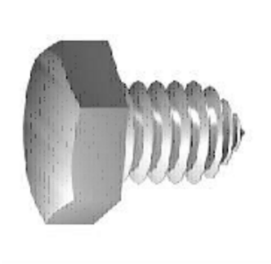

DVÍŘKA	POZICE	POPIS	KÓD	ČÍSLO SOUČÁSTI	POČET KS	POZNÁMKY
	1	DVÍŘKA	PKTX0211	397.005.000.A3	1	
	2	KRYT DVÍŘEK	PKMD0090	397.012.000.A3	1	
	3	KERAMIKA NA DVÍŘKA	MTKE0004	001.005.008.A4	1	
	4	Podložka - 8,4	MSPX0008	DIN 9021	2	
	5	TĚSN. ŠŇŮRA 18x18	MRUZ0133		1.62m	
	6	IZOLACE DVÍŘEK 20x469x449	MTIZ0011		1	

DVÍŘKA	POZICE	POPIS	KÓD	ČÍSLO SOUČÁSTI	POČET KS	POZNÁMKY
	7	IZOLACE TĚLA 20x388x370	MTIZ0005		1	
	8	TYČ ZÁVITOVÁ M8x95	PKTX0117		2	
	9	Šroub do plechu - ST4,2 x 13	MSSX0012	ISO 1479	2	
	10	NÝT 10x50 Fe	MSRX0032	DIN 660	2	
	11	Šestihrné matice - M8	MSMX0016	ISO 4032	2	

VYMETÁNÍ POPELE

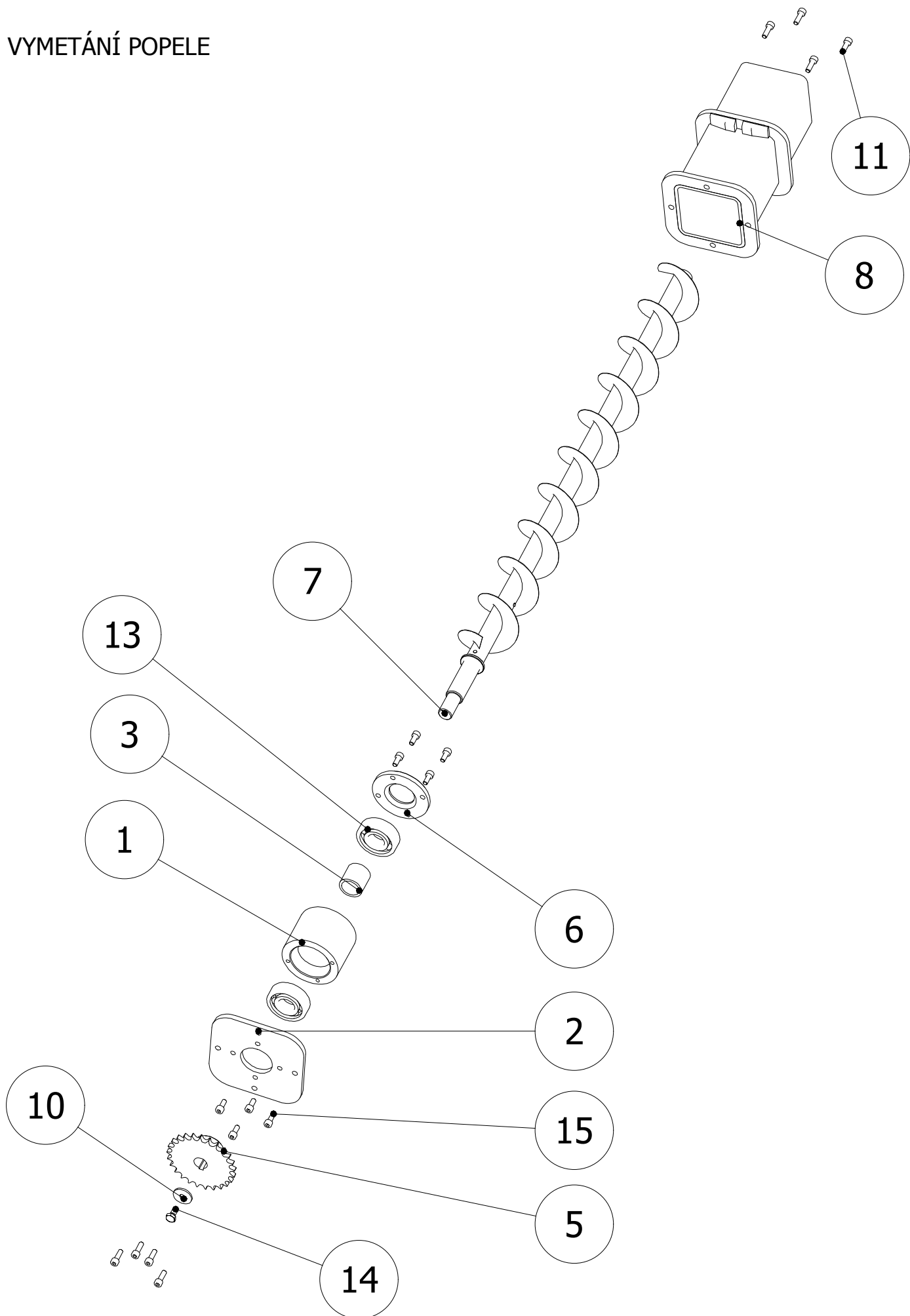

Vymetání popele	POZICE	POPIS	KÓD	ČÍSLO SOUČÁSTI	POZICE KS	POZNÁMKY
	1	NÁBOJ	PKTX0140	334.001.000.A4	1	
	2	VÍKO 1	PKTX0150	334.002.000.A4	1	
	3	DISTANCE	PKTX0440	334.003.000.A4	1	
	5	KOLO ŘETĚZOVÉ S NÁB.3/8"x7/32"	PKTX0143	334.005.000.A4	1	
	6	VÍKO 2	PKTX0144	334.006.000.A4	1	
	7	ŠNEK	PKTX0219	398.S07.000.A3	1	

Vymetání popele	POZICE	POPIS	KÓD	ČÍSLO SOUČÁSTI	POZICE KS	POZNÁMKY
	8	VEDENÍ ŠNEKU	PKTX0153	334.S08.000.A3	1	
	10	Podložka 6	MSPX0002	DIN 440R	1	
	11	Šroub s válcovou hlavou - M5 x 16	MSSX0055	DIN 912	8	
	12	Těsné pero - A 5 x 5 x 22	MSRX0006	DIN 6885	1	
	13	Kuličková ložiska jednořadá - 6204 2Z	MRUZ0049	CSN 02 4630	2	
	14	Šestihranný šroub - M6 x 10	MSSX0019	DIN 933	1	Zn

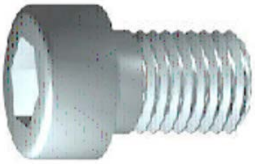

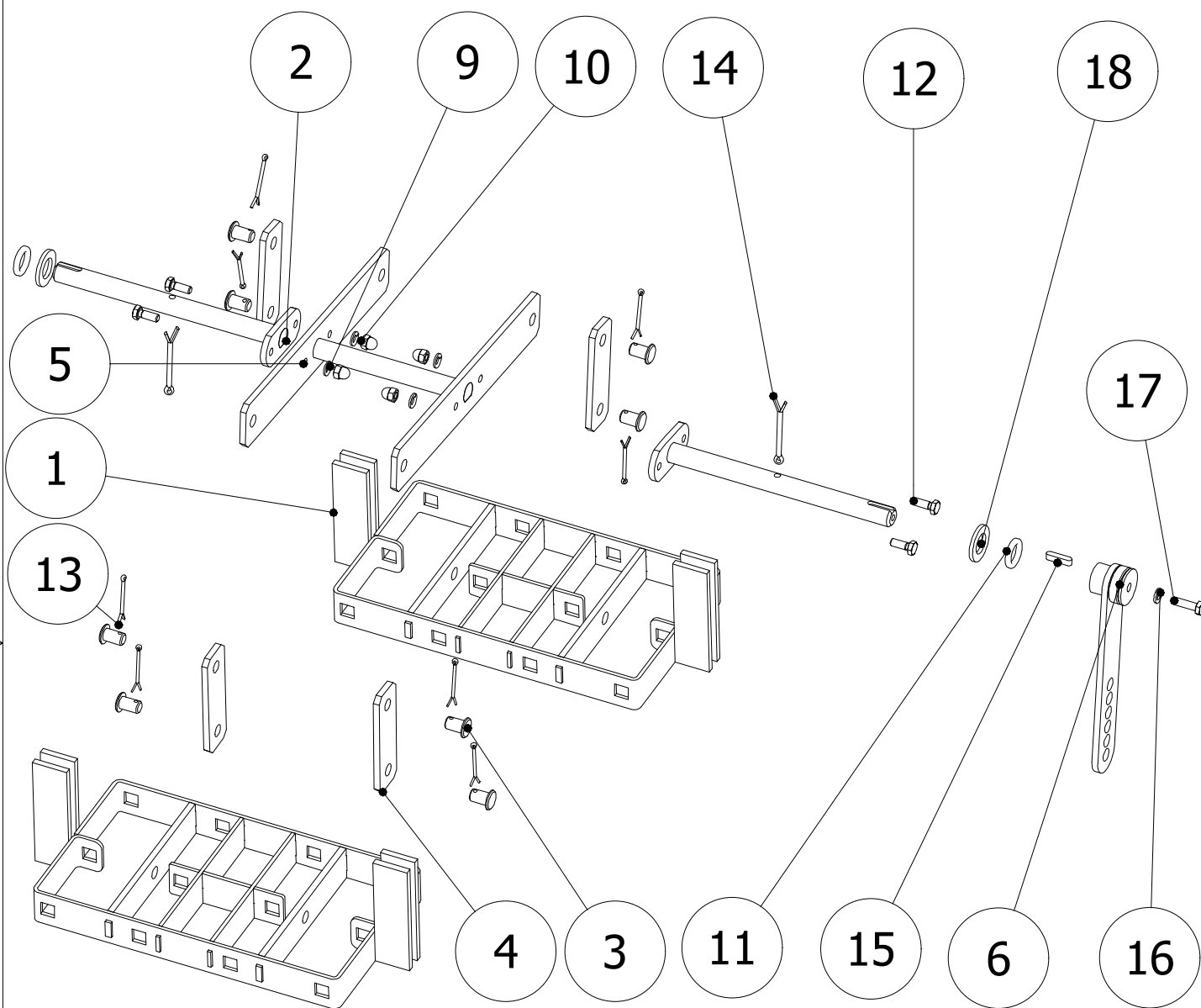

Vymetání popele	POZICE	POPIS	KÓD	ČÍSLO SOUČÁSTI	POZICE KS	POZNÁMKY
	15	Šroub s válcovou hlavou - M5 x 12	MSSX0137	DIN 912	8	

ČISTĚNÍ VÝMĚNÍKU



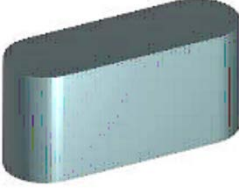

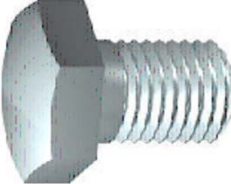

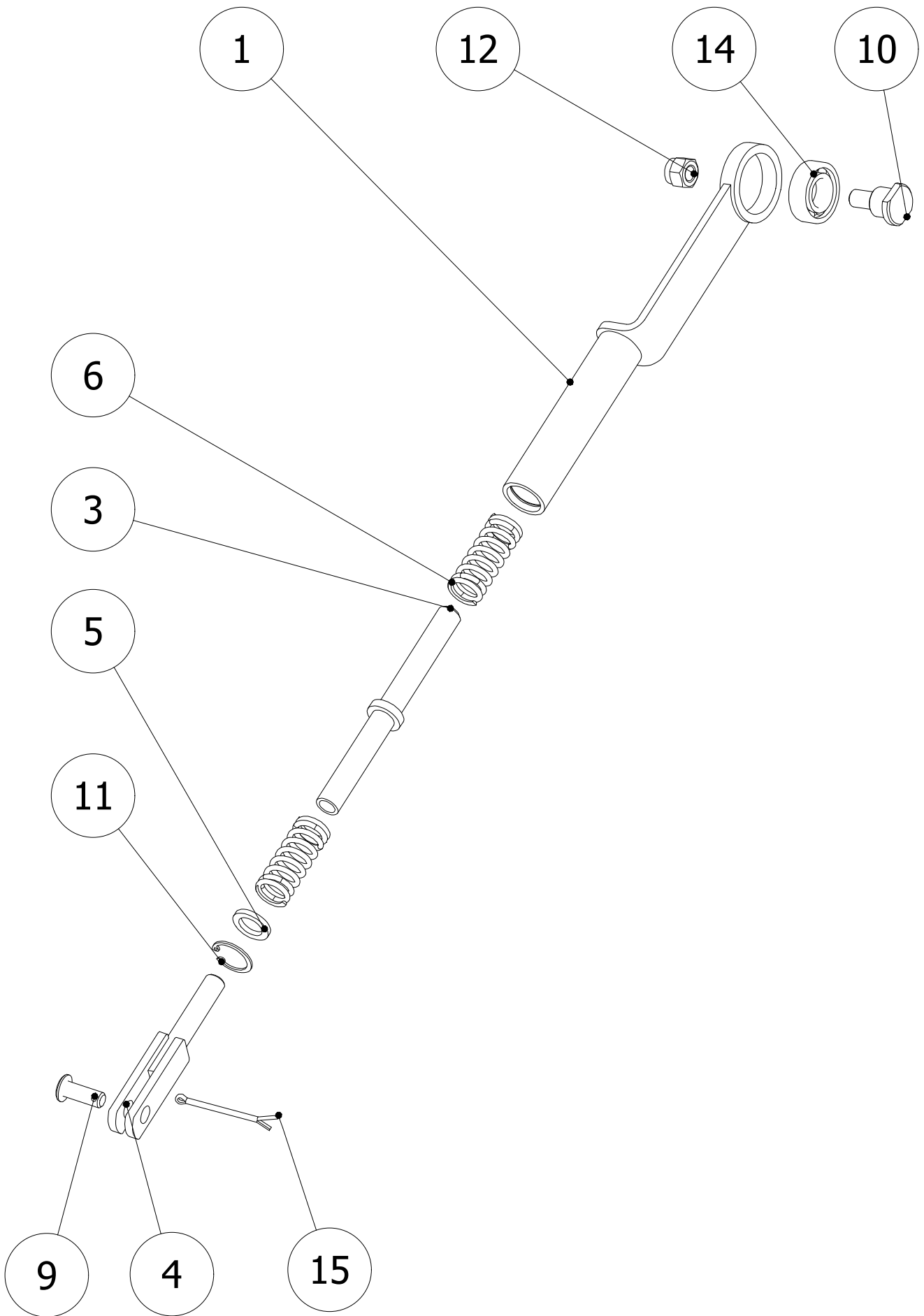

ČISTĚNÍ VÝMĚNÍKU	POZICE	POPIS	KÓD	ČÍSLO SOUČÁSTI	POČET KS	POZNÁMKY
	1	VAHADLO	PKTX0388	796.S01.000.A3	2	
	2	NÁSTAVEC	PKTX0387	796.S06.S00.A4	2	
	3	ČEP	PKTX0053	005.S16.007.A4	8	
	4	ZÁVĚS	PKTX0051	005.S16.004.A4	4	
	5	HŘÍDEL SPOJOVACÍ	PKTX0326	758.S06.A00.A3	1	
	6	RAMENO	PKTX0163	445.S08.000.A4	1	

ČISTĚNÍ VÝMĚNÍKU	POZICE	POPIS	KÓD	ČÍSLO SOUČÁSTI	POČET KS	POZNÁMKY
	9	Pružná podložka - A6	MSPX0019	DIN 128	4	
	10	Šestihranná matice uzavřená - M6	MSMX0027	DIN 1587	4	
	11	Šňůra těs. čistění 4x4	PKTX0432		2	
	12	Šestihranný šroub - M6 x 16	MSSX0015	DIN 933	4	
	13	Závlačka - 2,5 x 36	MSRX0048	ISO 1234	8	
	14	Závlačka - 4 x 50	MSRX0021	ISO 1234	2	

ČISTĚNÍ VÝMĚNÍKU	POZICE	POPIS	KÓD	ČÍSLO SOUČÁSTI	POČET KS	POZNÁMKY
	15	Těsné pero - A 5 x 5 x 22	MSRX0006	DIN 6885	1	
	16	Ploché podložky - 6 - 140 HV	MSPX0026	ISO 7089	1	
	17	Šestihranný šroub - M6 x 20	MSSX0006	ISO 4017	1	Zn
	18	Podložka 16	MSPX0030	DIN 125	2	

MECHANISMUS ČISTĚNÍ



Mechanismus čistění	POZICE	POPIS	KÓD	ČÍSLO SOUČÁSTI	POČET KS	POZNÁMKY
	1	OJE ČISTĚNÍ	PKTX0167	424.S01.000.A4	1	
	3	ČEP VEDENÍ	PKTX0170	424.003.000.A4	1	
	4	VIDLICE	PKTX0171	424.S04.000.A4	1	
	5	VÍČKO	MHVT0139	424.005.000.A4	1	
	6	PRUŽINA TLAČNÁ	MRUZ0065		2	
	9	ČEP 1	PKTX0175	424.009.000.A4	1	

Mechanismus čišění	POZICE	POPIS	KÓD	ČÍSLO SOUČÁSTI	POČET KS	POZNÁMKY
	10	ČEP	PKTX0176	424.010.000.A4	1	
	11	Pojistné kroužky pro díry - 22	MSRX0014	CSN 02 2931	1	
	12	Samojistné šestihřanné matice - M10	MSMX0006	ISO 7041	1	
	14	Kuličková ložiska jednořadá - 6003 2RS	MRUZ0048	CSN 02 4630	1	
	15	Závlačka - 3,2 x 50	MSRX0059	ISO 1234	1	

POHON ČISTĚNÍ

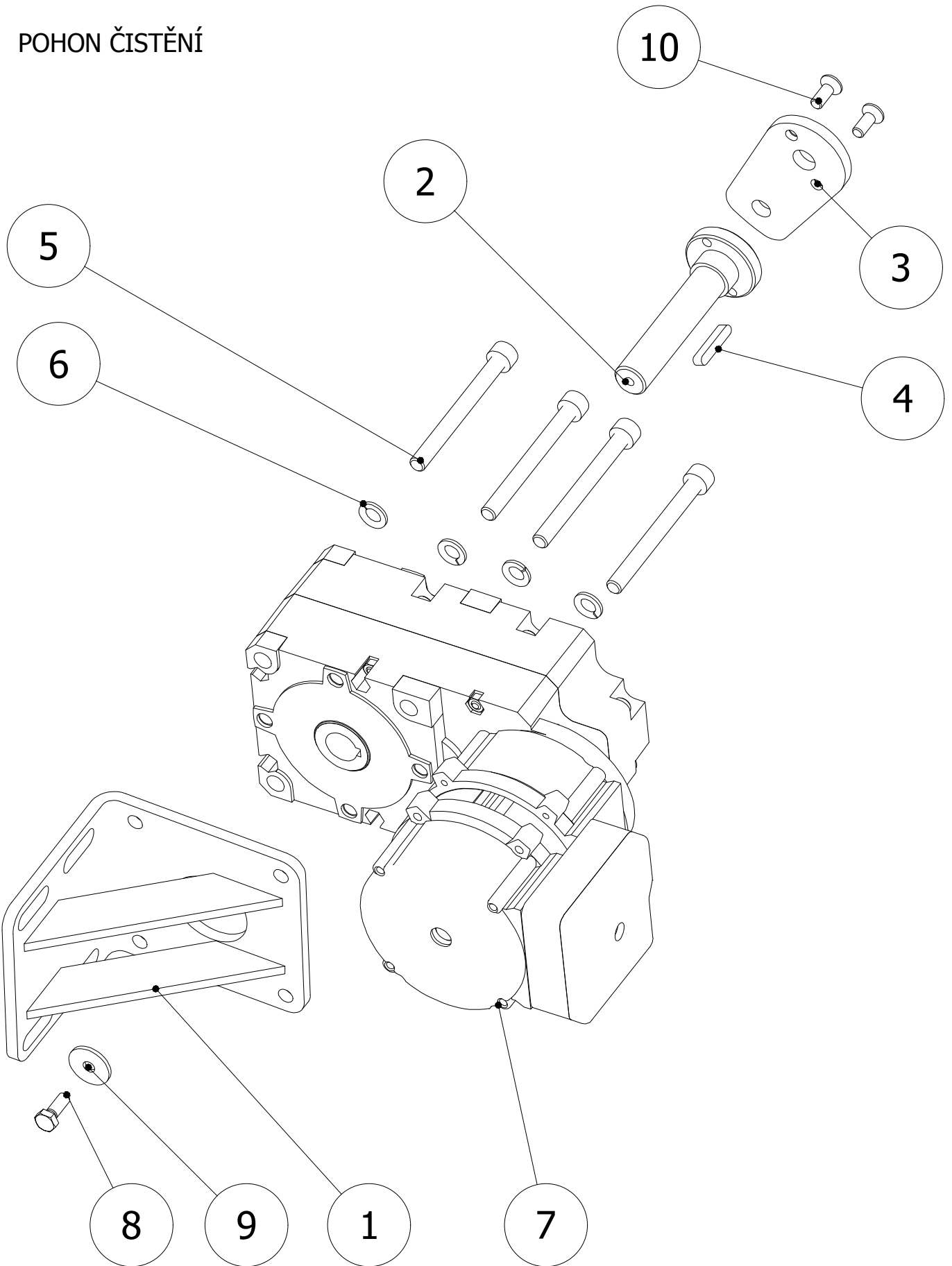

POHON ČISTĚNÍ TAHŮ	POZICE	POPIS	KÓD	ČÍSLO SOUČÁSTI	POČET KS	POZNÁMKY
	1	DRŽÁK MOTORU ABM	PKTX0216	446.S01.000.A3	1	
	2	UNAŠEČ	PKTX0218	446.002.000.A3	1	
	3	PÁKA	PKTX0179	397.S25.003.A4	1	
	4	Těsné pero - A 5 x 5 x 30	MSRX0007	DIN 6885	1	
	5	Šroub s válcovou hlavou - M8 x 80	MSSX0045	DIN 912	4	
	6	Pružná podložka - A8	MSPX0006	DIN 128	4	

POHON ČISTĚNÍ TAHŮ	POZICE	POPIS	KÓD	ČÍSLO SOUČÁSTI	POČET KS	POZNÁMKY
	7	Motor EPO MRB 0,12kW/2p	MEMP0065		1	
	8	Šestihranný šroub - M6 x 16	MSSX0015	DIN 933	1	
	9	Podložka 6	MSPX0002	DIN 440R	1	
	10	Šroub se zápusťnou hlavou - M6 x 16	MSSX0096	DIN 7991	2	
	11	Kabel SIHF 3G 1	MEKV0003		1.5m	

POHON VYMETÁNÍ POPELE

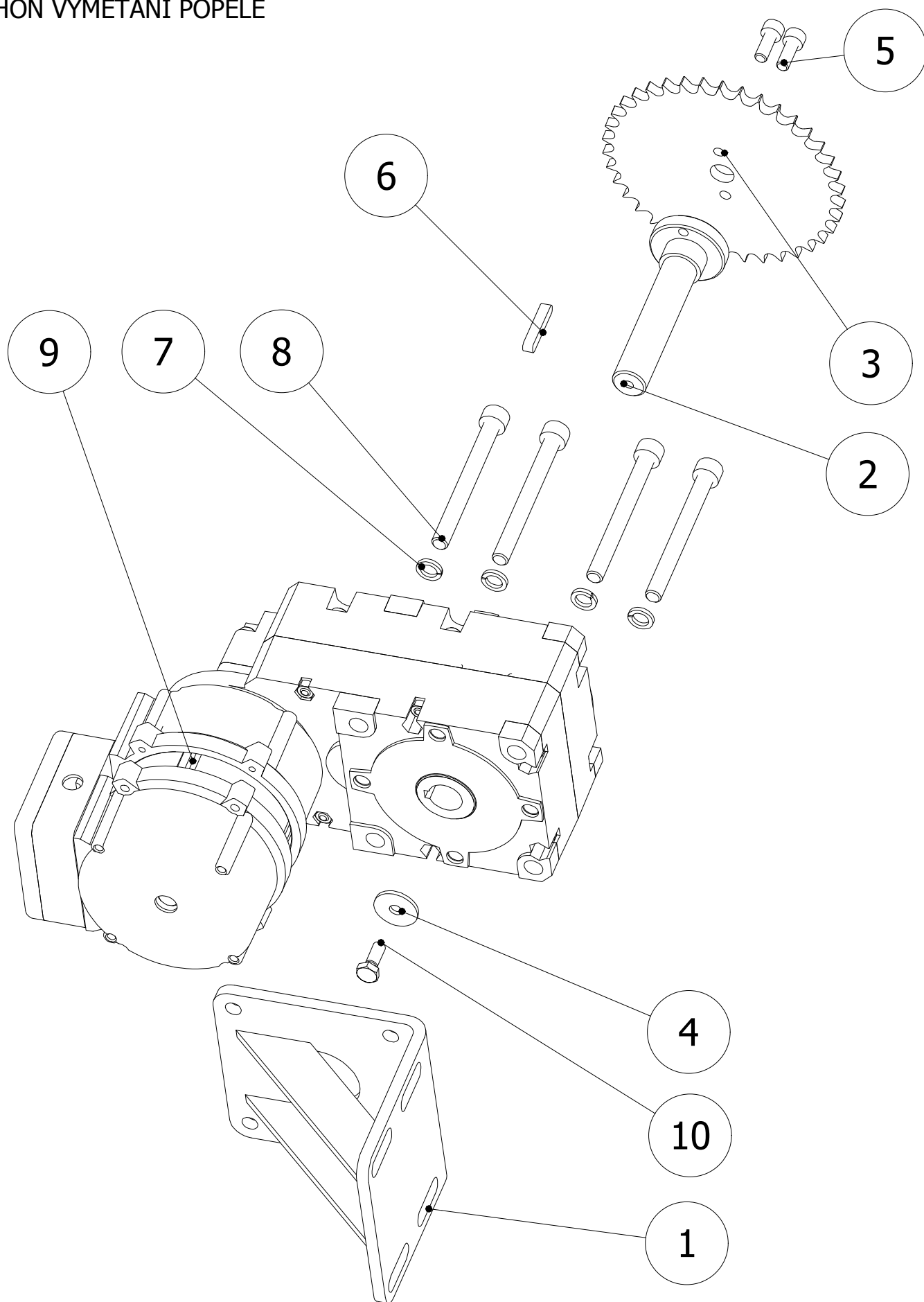







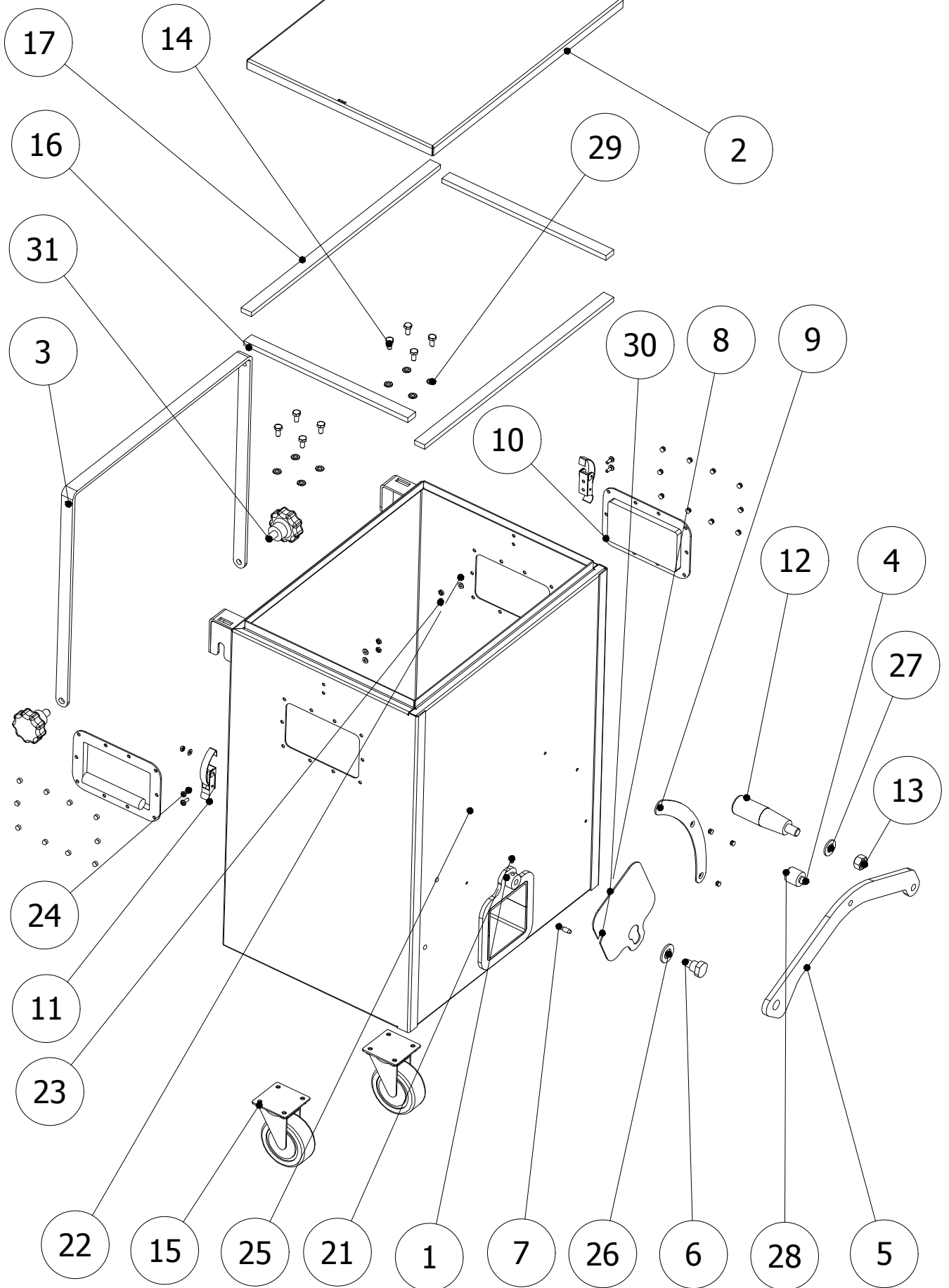

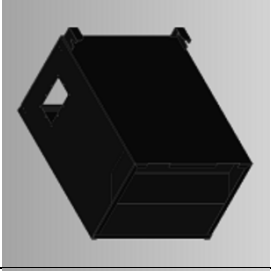

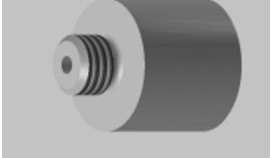
Pohon vymetání popelé	POZICE	POPIS	KÓD	ČÍSLO SOUČÁSTI	POČET KS	POZNÁMKY
	1	DRŽÁK MOTORU ABM	PKTX0216	446.S01.000.A3	1	
	2	UNAŠEČ	PKTX0218	446.002.000.A3	1	
	3	KOLO ŘETĚZOVÉ ÚPRAVA	PKTX0225	446.003.000.A4	1	
	4	Podložka 6	MSPX0002	DIN 440R	1	
	5	Šroub s válcovou hlavou - M6 x 16	MSSX0098	ISO 4762	2	
	6	Těsné pero - A 5 x 5 x 30	MSRX0007	DIN 6885	1	

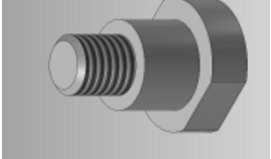

Pohon vymetání popela	POZICE	POPIS	KÓD	ČÍSLO SOUČÁSTI	POČET KS	POZNÁMKY
	7	Pružná podložka - 8	MSPX0006	DIN 7980	4	
	8	Šroub s válcovou hlavou - M8 x 80	MSSX0045	DIN 912	4	
	9	Motor EPO MRB 0,06kW/4p	MEMP0040		1	
	10	Šestihranný šroub - M6 x 16	MSSX0015	DIN 933	1	
	11	ŘETĚZ 06 B-1, 103 ČLÁNKŮ (3.8x7.32)	MRUZ0141		1	
	12	ČLÁNEK SPOJOVACÍ JEDNOŘ.	MRUZ0041		1	
	13	KABEL SIHF 3G 1	MEKV0003		1.2m	

POPELNICE 80L

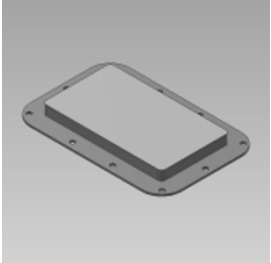

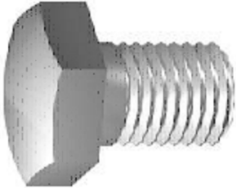

Popelnice 80L	POZICE	POPIS	KÓD	ČÍSLO SOUČÁSTI	POČET KS	POZNÁMKY
	1	POPELNICE	PKTD0251	448.S01.000.A3	1	
	2	DEKL POPELNICE 80L	PKTC0256	448.S03.000.A4	1	
	3	DRŽADLO	PKTD0199	448.011.000.A4	1	
	4	DRŽÁK MAGNETICKÝ	PKTX0198	448.009.000.A4	1	
	5	PÁKA	PKTD0196	448.005.000.A3	1	
	6	ŠROUB	PKTX0197	448.006.000.A4	1	

Popelnice 80L	POZICE	POPIS	KÓD	ČÍSLO SOUČÁSTI	POČET KS	POZNÁMKY
	7	DISTANCE	PKMX0037	054.009.003.A4	1	
	8	ZÁKLOPKA	MHVT0186	448.012.000.A4	1	
	9	DRÁHA	PKTX0201	448.028.000.A4	1	
	10	Ocelová sklápěcí rukojeť 147x110 mm	MRUZ0055		2	
	11	UZÁVĚR UP3	MRUZ0010		2	
	12	DLOUHÁ KUŽ. RUKOJEŤ	MRUZ0062	OBJ.Č.460650	1	

Popelnice 80L	POZICE	POPIS	KÓD	ČÍSLO SOUČÁSTI	POČET KS	POZNÁMKY
	13	Šestihránné matice - M12	MSMX0007	ISO 4032	1	
	14	Šrouby se šestihránnou hlavou - M6 x 12	MSSX0083	ISO 4017	8	
	15	Šestihránné matice - M6	MSMX0001	ISO 4032	8	
	16	TĚSNĚNÍ SILIKONOVÉ 8x18-290	MRUZ0066		2	
	17	TĚSNĚNÍ SILIKONOVÉ 8x18-443	MRUZ0122		2	
	20	KOLO PEVNÉ EGA 075/FLP PR.75	MRUZ0056	FA.MONTAKO	2	

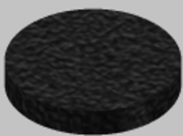
Popelnice 80L	POZICE	POPIS	KÓD	ČÍSLO SOUČÁSTI	POČET KS	POZNÁMKY
	21	Stavěcí šrouby - M5 x 10	MSRX0015	ISO 4027	1	
	22	Ploché podložky - 4	MSPX0014	ISO 7089	5	
	23	Šestihranné matice - M4	MSSX0012	ISO 4032	5	
	24	Šrouby s válc. hl. s kří. drážk. - M4 x 10	MSSX0010	ISO 7045	4	
	25	Nýt - B 4 x 8	MSRX0064	DIN 660	3	
	26	Podložka - A 16	MSPX0022	DIN 125	1	

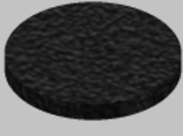
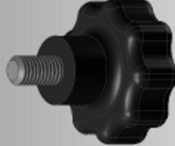
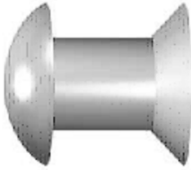
Popelnice 80L	POZICE	POPIS	KÓD	ČÍSLO SOUČÁSTI	POČET KS	POZNÁMKY
	27	Ploché podložky - 12	MSPX0020	ISO 7089	1	
	28	MAGNET 18x3	MRUZ0088		1	
	29	Ploché podložky - 6	MSPX0026	ISO 7090	8	
	30	MAGNET 18x2	MRUZ0077		1	
	31	ŠROUB KOVOVÝ S PLAST.HLAV OU M10x17	MRUZ0032	OBJ.Č.105a-068-D/MxL	2	
	32	NÝT TRHACÍ 4x8 AL/ST	MSRX0013		23	

HORÁK A302

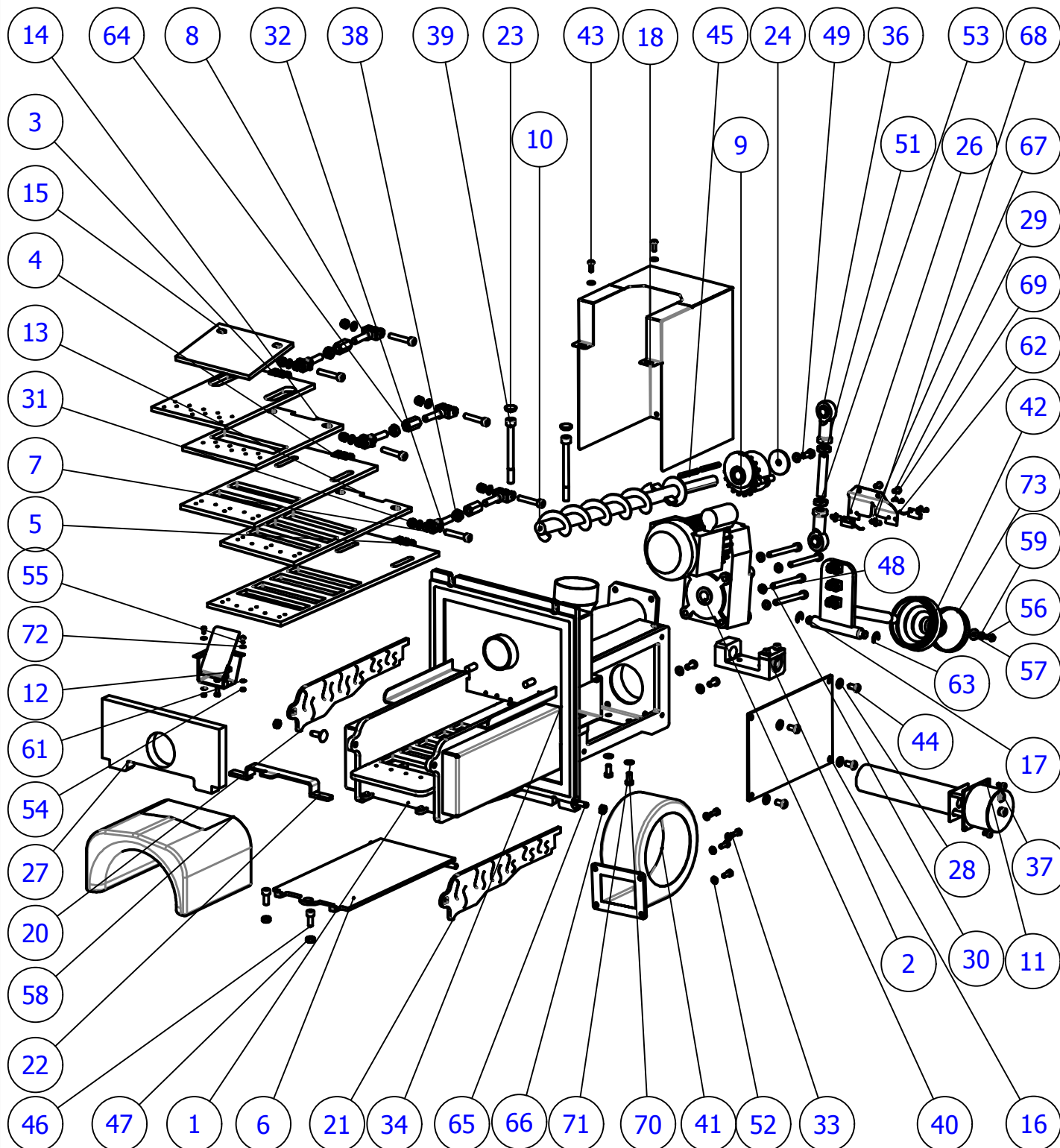

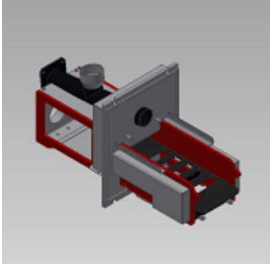
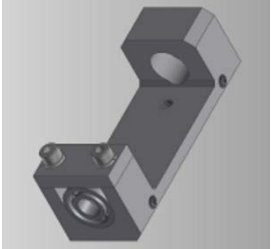
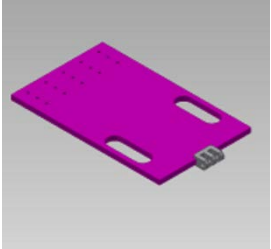
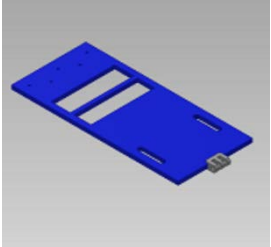
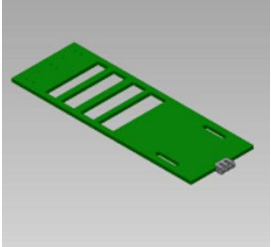

HOŘÁK A302	POZICE	POPIS	KÓD	ČÍSLO SOUČÁSTI	POČET KS	POZNÁMKY
	1	TĚLESO HOŘÁKU	PVHXX3000	886.S01.000.A1	1	
	2	DOMEČEK ROŠTOVÁNÍ	PVHXX0149	875.A02.000.A4	1	Sestava
	3	ROŠTNICE 1	PVHXX0097	886.S03.000.A3	1	
	4	ROŠTNICE 2	PVHXX0099	886.S04.000.A3	1	
	5	ROŠTNICE 3	PVHXX0101	886.S05.000.A3	1	
	6	KRYT SPODNÍ	PVHXX0103	886.S06.000.A3	1	

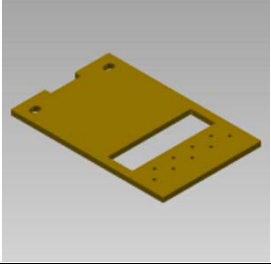
HOŘÁK A302	POZICE	POPIS	KÓD	ČÍSLO SOUČÁSTI	POČET KS	POZNÁMKY
	7	UNAŠEČ 1	PVHXX0043	875.S07.000.A4	3	
	8	UNAŠEČ 2	PVHXX0045	875.S08.000.A4	3	
	9	PŘEVODOVKA ND set	PVHXX0145	875.S09.000.A4	1	Sestava
	10	ŠNEK HOŘÁKU	PVHXX0124	886.S10.000.A3	1	
	11	SYSTÉM ZAPALOVÁNÍ A302,A602	PVHXX0059	875.S11.000.A3	1	Sestava
	12	KLAPKA	PVHXX0107	886.S12.000.A4	1	Sestava

HOŘÁK A302	POZICE	POPIS	KÓD	ČÍSLO SOUČÁSTI	POČET KS	POZNÁMKY
	13	DESKA STÍRACÍ 3	PVHXX0114	886.013.000.A4	1	
	14	DESKA STÍRACÍ 2	PVHXX0115	886.014.000.A4	1	
	15	DESKA STÍRACÍ 1	MVHVVH0126	886.015.000.A4	1	
	16	VÍKO	PVHXX0122	886.016.000.A4	2	
	17	PÁKA ROŠTOVACÍ	PVHXX0135	875.S02.000.A3	1	
	18	KRYT POHONU	PVHXX0083	875.018.000.A3	1	

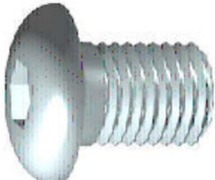
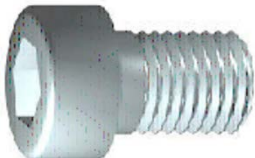
HOŘÁK A302	POZICE	POPIS	KÓD	ČÍSLO SOUČÁSTI	POČET KS	POZNÁMKY
	20	DESKA CHRÁNIČE	PVWHX0067	886.S20.001.A4	2	
	22	ROZRAŽEČ	PVHXX0151	886.A22.000.A4	1	PVHXX0144 původní
	23	ZÁTKA	PVHXX0134	886.023.000.A4	2	
	24	PODLOŽKA	PVHXX0070	875.020.000.A4	1	
	26	DRŽÁK SNÍMAČE	PVHXX0074	875.030.000.A4	1	
	27	DESKA 20x131x260	MTIZ0100	886.060.000.A4	1	

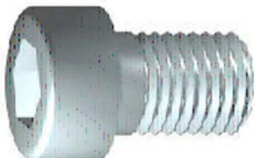
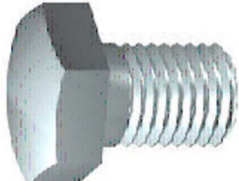
HOŘÁK A302	POZICE	POPIS	KÓD	ČÍSLO SOUČÁSTI	POČET KS	POZNÁMKY
	28	Podložka - A 6,4	MSPX0026	DIN 125	8	
	29	Šrouby s půlk.hl. s vnitř.šestihř. - M6 x 12	MSSX0141	ISO 7380	2	
	30	Šroub s válcovou hlavou - M8 x 80	MSSX0045	DIN 912	4	
	31	Samojistná šestihřanná matice - M8	MSMX0003	ISO 7040	6	
	32	Šroub s válcovou hlavou - M8 x 45	MSSX0221	DIN 912	6	
	33	Šestihřanný šroub - M6 x 16	MSSX0015	ISO 4017	4	

HOŘÁK A302	POZICE	POPIS	KÓD	ČÍSLO SOUČÁSTI	POČET KS	POZNÁMKY
	34	TĚSNĚNÍ SAMOLEPÍCÍ 2x20	MRUZ0328		2m	
	36	OKO KLOUBOVÉ GN 648.1-14-M14-W	MRUZ0445		2	
	37	Šroub IMB. - M5 x 10	MSSX0026	CSN 02 1143	2	
	38	Šestihranná matice - M10	MSSX0002	DIN 934	3	
	39	Šroub IMB. - M10 x 110	MSSX0219	CSN 02 1143	2	
	40	Motor FT105 U88,9/40W	MEMPO040		1	

HOŘÁK A302	POZICE	POPIS	KÓD	ČÍSLO SOUČÁSTI	POČET KS	POZNÁMKY
	41	Ventilátor RG12S-2EP	PKRX0132		1	
	42	Manžeta poloosy ke kolu UNI 5786	MEMP0043		1	
	43	Šrouby s půlk.hl. s vnitř.šestihř.- M6 x 16	MSSX0194	ISO 7380	2	
	44	Šrouby s půlk.hl. s vnitř.šestihř.- M8 x 16	MSSX0135	ISO 7380	8	
	45	Těsné pero - A 5 x 5 x 56	MSRX0128	DIN 6885	2	
	46	Šroub s válcovou hlavou - M8 x 20	MSSX0071	DIN 912	2	

HOŘÁK A302	POZICE	POPIS	KÓD	ČÍSLO SOUČÁSTI	POČET KS	POZNÁMKY
	47	Šestihránné matice - M8	MSMX0016	ISO 4032	2	
	48	Pružná podložka - A 8	MSPX0006	DIN 127	5	
	49	Šestihránný šroub - M8 x 20	MSSX0002	DIN 933	1	
	51	TYČ ZÁVITOVÁ M14-75 Zn	PVHXX0076		1	
	52	Podložka - A 8,4	MSPX0001	DIN 125	6	
	53	Šestihránná matice - M14	MSMX0044	DIN 439	2	

HOŘÁK A302	POZICE	POPIS	KÓD	ČÍSLO SOUČÁSTI	POČET KS	POZNÁMKY
	54	Šestihranná matice - M4	MSMX0012	DIN 934	2	
	55	Šrouby s válcovitou hlavou - M4 x 8	MAZD0221	ISO 7045	2	
	56	Šestihranný šroub - M6 x 16	MSSX0015	DIN 933	2	
	57	Podložka - 6,4	MSPX0002	DIN 9021	2	
	58	REFLEKTOR KERAMICKÝ V 30KW	MTKE0119	886.050.000.A3	1	
	59	Zubová pojistná podložka - A 6,4	MSPX0012	DIN 6797	2	

HOŘÁK A302	POZICE	POPIS	KÓD	ČÍSLO SOUČÁSTI	POČET KS	POZNÁMKY
	61	Zoubkovaná pojistná podložka - 4,3	MSPX0010	CSN 02 1745	2	
	62	Snímač MEDER MK04-1A66-dl. 1900mm	MERX0777		2	
	63	Pojistné třmenové kroužky - 9	MSRX0136	CSN 02 2929	2	
	64	Matice M10x13x25 spojovací	MSMX0013		3	
	65	Šroub s půkl.hl. a čtverh. krčkem - M8 x 25	MSSX0239	DIN 603	2	NEREZ
	66	Šestihranná matice - M8	MSMX0016	DIN 934	2	

HOŘÁK A302	POZICE	POPIS	KÓD	ČÍSLO SOUČÁSTI	POČET KS	POZNÁMKY
	67	Šestihranná matice - M3	MSMX0008	DIN 934	4	
	68	Zubová pojistná podložka - A 3,2	MSPX0029	DIN 6797	4	
	69	Šroub se zápuštnou hlavou - M3 x 16	MSSX0170	ISO 7045	4	
	70	Šroub s válcovou hlavou- M8 x 16	MSSX0179	DIN 7984	4	
	71	Pružná podložka - A8	MSPX0006	DIN 128	10	
	72	Podložka - A 4,3	MSPX0014	DIN 125-2	2	

HOŘÁK A302	POZICE	POPIS	KÓD	ČÍSLO SOUČÁSTI	POČET KS	POZNÁMKY
	73	SPONA HADICOVÁ 70-90 NEREZ	MRUZ0089		1	
	74	SPONA HADICOVÁ 16-25 NEREZ	MRUZ0250		1	
	75	SPONA HADICOVÁ 60-80 NEREZ	MRUZ0268		1	

DOMEČEK ROŠTOVÁNÍ A302, A602

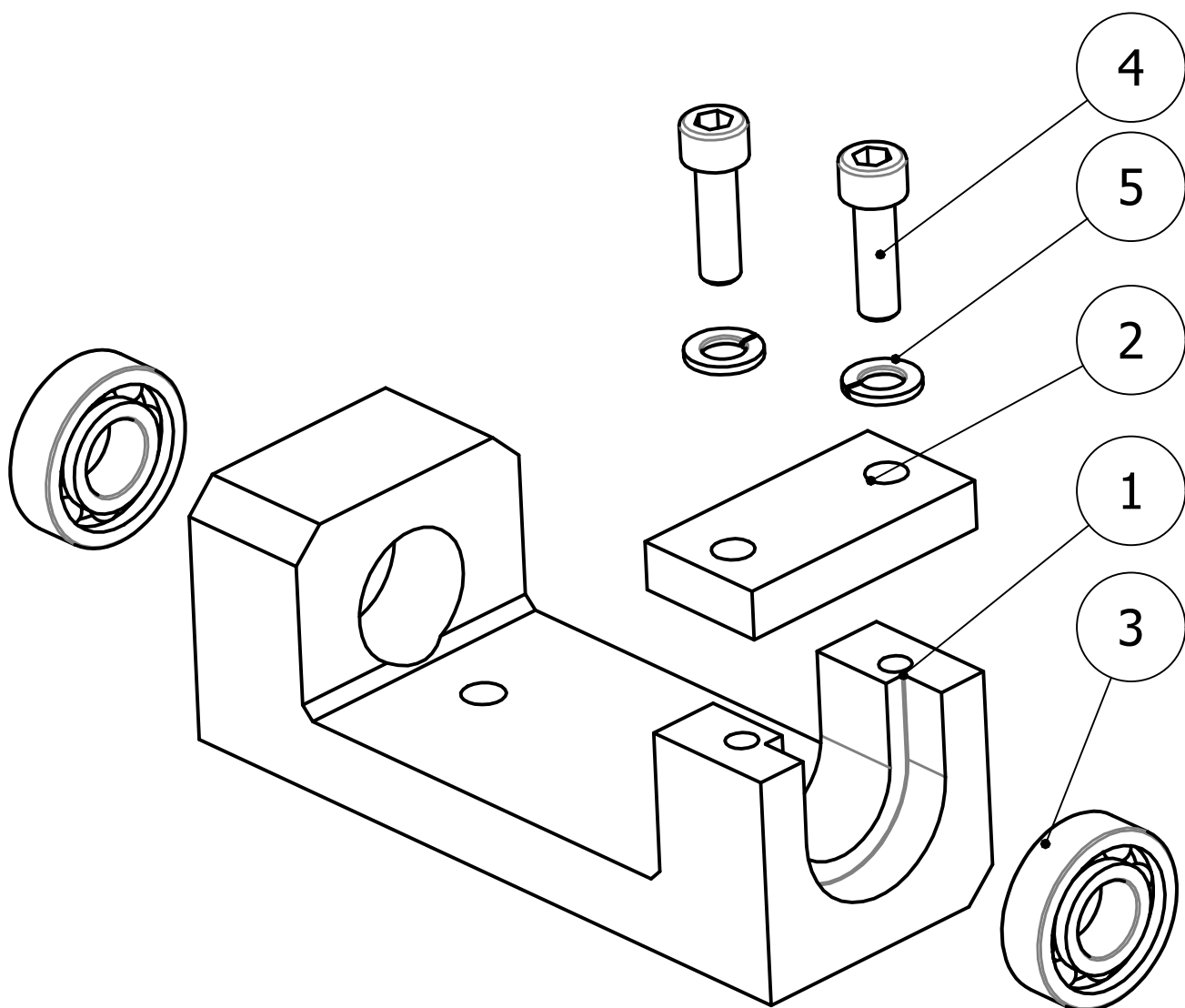

Domeček	POZICE	POPIS	KÓD	ČÍSLO SOUČÁSTI	POČET KS	POZNÁMKY
	1	DOMEČEK	MRUZ0489	875.A02.001.A 3	1	
	2	1/2 DOMEČEK U	MVHVH0137	875.A02.002.A 4	1	
	3	Kuličková ložiska jednořadá - 6001	MRUZ0485	CSN 02 4630	2	
	4	Šroub imbus - M6 x 20	MSSX0182	ISO 4762	2	
	5	Pružná podložka - A6	MSPX0019	DIN 128	2	

ROZPAD PŘEVODOVKY

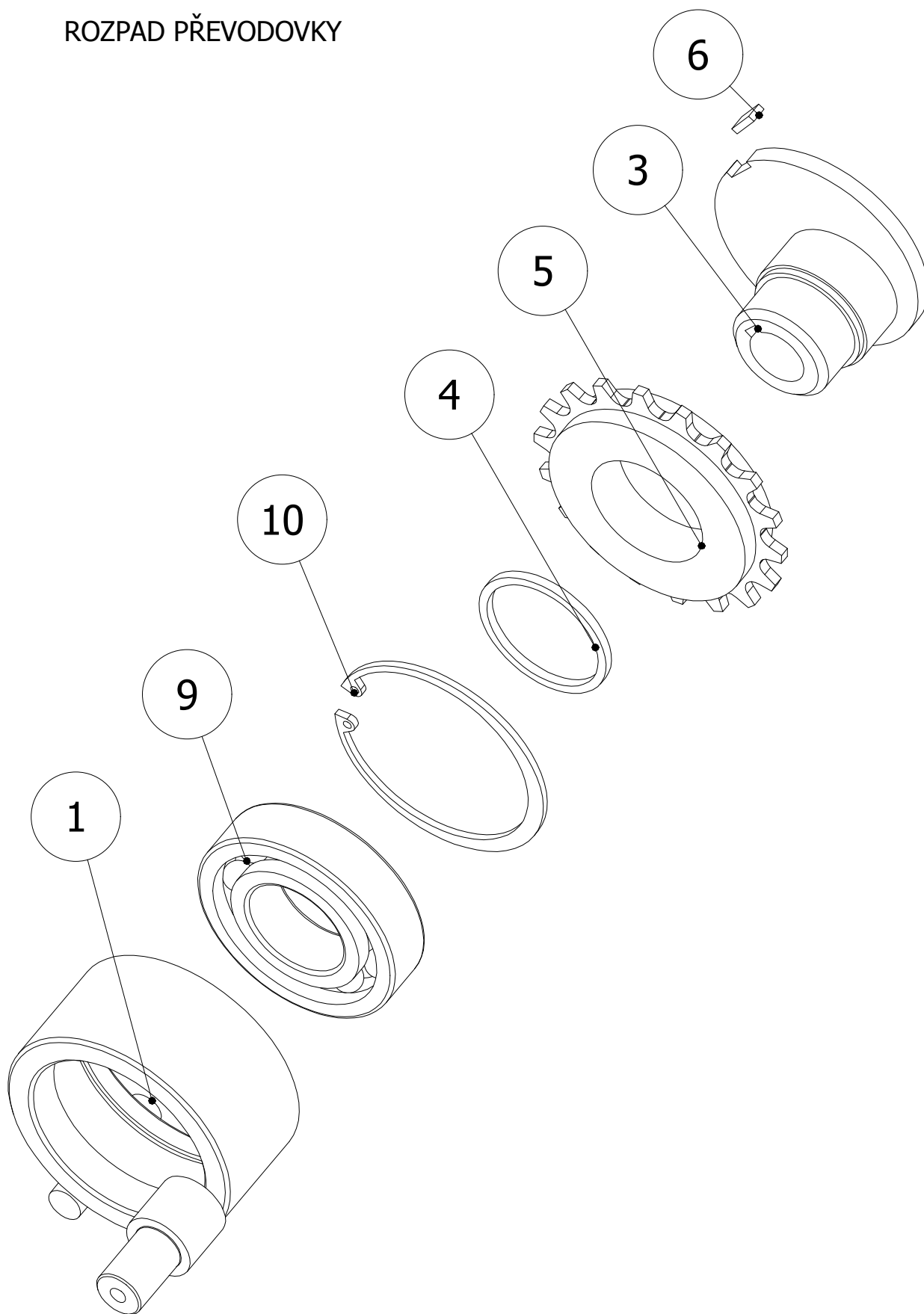



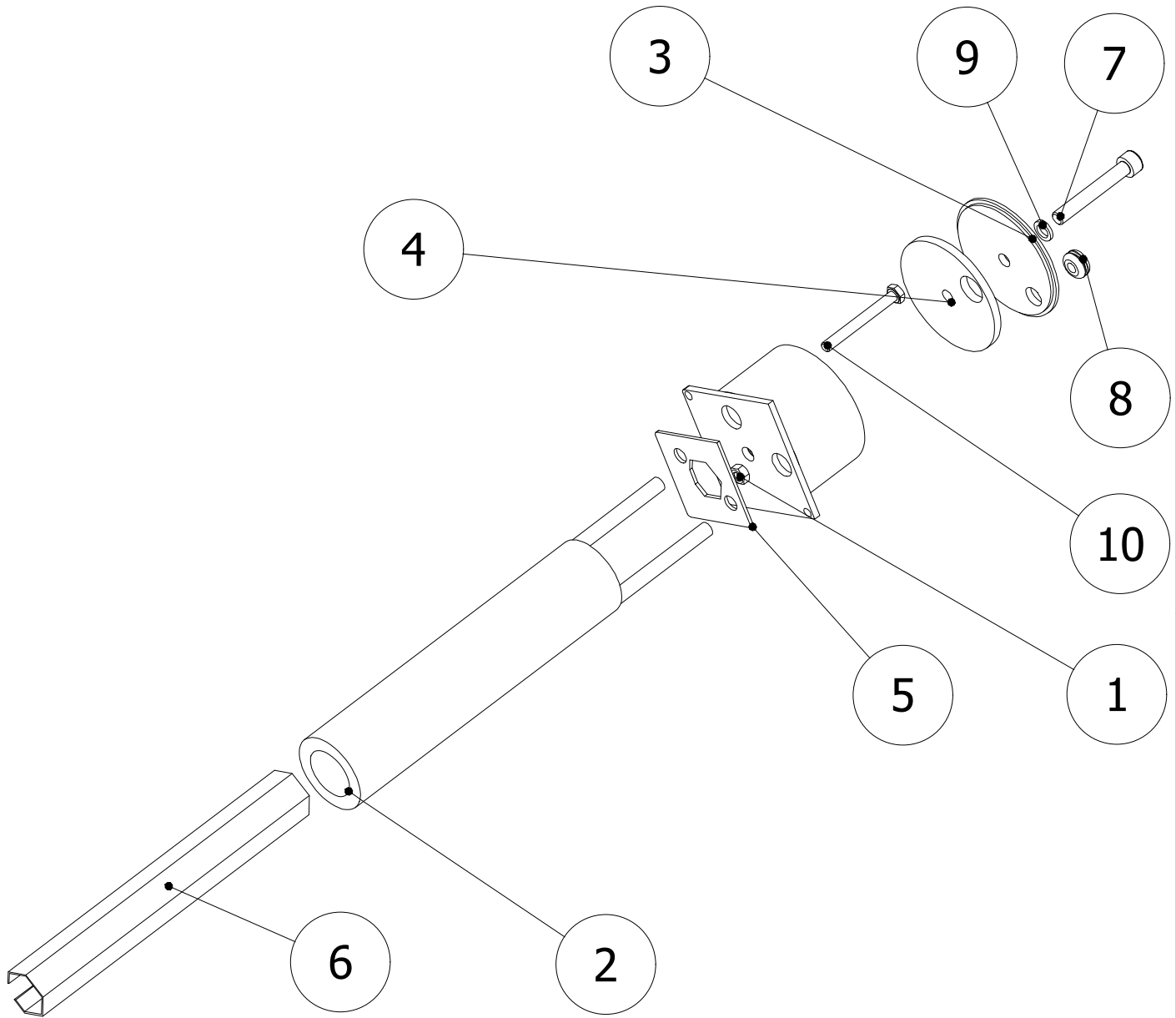

Převodovka	POZICE	POPIS	KÓD	ČÍSLO SOUČÁSTI	POČET KS	POZNÁMKY
	1	SKŘÍŇ PŘEVODOVKY	PVHXX0047	875.S09.S01.A4	1	
	3	NÁBOJ S VAČKOU	PVHXX0054	875.S09.S03.A4	1	
	4	DISTANCE	PVHXX0077	875.S09.004.A4	1	
	5	Kolo ozubené 18 zubů m50.0740	MRUZ0362		1	
	6	Magnet neodym.10x5x2 Au	MRUZ0484		2	
	9	Kuličková ložiska jednořadá - 6206 2RS	MRUZ0439	CSN 02 4630	1	

Převodovka	POZICE	POPIS	KÓD	ČÍSLO SOUČÁSTI	POČET KS	POZNÁMKY
	10	Pojistné kroužky pro otvory - 62	MSRX0113	CSN 022931	1	

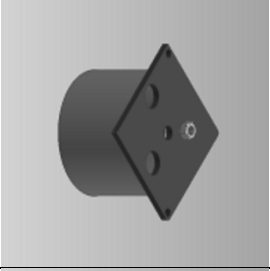
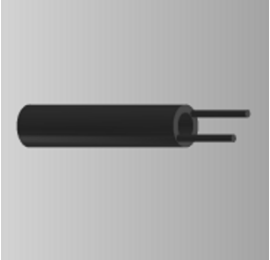
SYSTEM ZAPALOVÁNÍ A302,A602

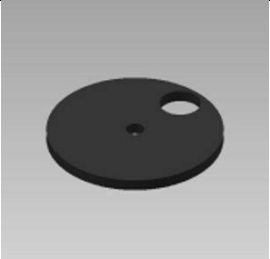
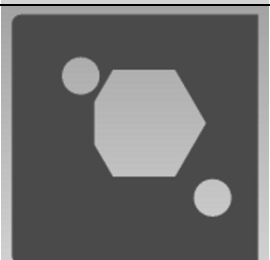

SYSTÉM ZAPALOVÁNÍ A302,A602	POZICE	POPIS	KÓD	ČÍSLO SOUČÁSTI	POČET KS	POZNÁMKY
	1	KRABICE ZAPALOVÁNÍ	PVHXX0148	875.A11.000.A4	1	
	2	Těleso topné 1200W/230V	MERX0671	m22.0222	1	
	3	KRYTKA ZAPALOVÁNÍ	PVHXX0081	886.S11.003.A4	1	
	4	TĚSNĚNÍ ZAPALOVÁNÍ	PVHXX0082	886.S11.004.A4	1	
	5	KRYTKA 2	MVHVH00	875.S11.005.A4	1	
	6	Jádro spirály P 1- 73.5x214	ZVKX0122		1	

SYSTÉM ZAPALOVÁNÍ A302,A602	POZICE	POPIS	KÓD	ČÍSLO SOUČÁSTI	POČET KS	POZNÁMKY
	7	Šroub s válcovou hlavou M8 x 55	MSSX0238	DIN 912	1	
	8	PRŮCHODKA 16x6.4x12.5x1.6x8	MRUZ0403	Obj.č.10605	1	
	9	Pružná podložka - 8	MSPX0006	DIN 7980	1	
	10	Šestihranný šroub - M6 x 55	MSSX0237	ISO 4017	1	

KLAPKA

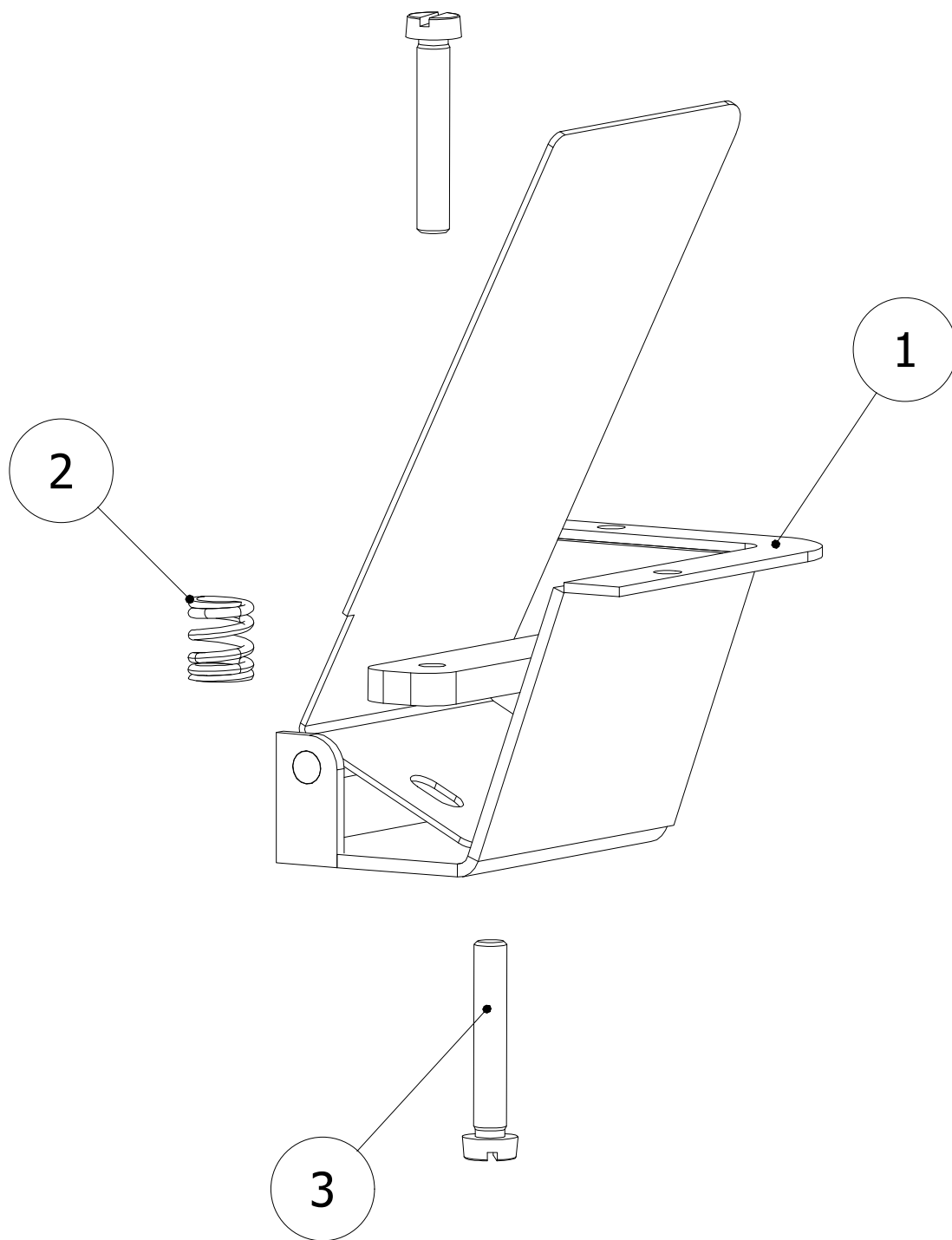

Klapka	POZICE	POPIS	KÓD	ČÍSLO SOUČÁSTI	POČET KS	POZNÁMKY
	1	TĚLO KLAPKY	PVHXX0106	886.A12.000.A4	1	
	2	PRUŽINA TLAČNÁ	MRUZ0493	886.S12.010.A4	1	
	3	Šroub s válcovou hlavou - M5 x 25	MSSX0227	ISO 1207	2	

ELEKTRO

KÓD	POPIS	MNOŽSTVÍ
MEKV0003	Kabel SIHF 3G 1	3,44 m
MEKV0037	Kabel H07V-K 1,5 zž	3,0 m
MEKV0047	Šňůra FLEX H05VV-F 3x1,5 5m	1,0 ks
MEKV0071	Kabel H07V-K 1,5 sv.modr	2,5 m
MEKV0072	Kabel H07V-K 1,5 černý	3,0 m
MERX0003	Objímka plochá BF-F 608P	3,0 ks
MERX0004	Dutinka lis. DI 1.0-10 10	20,0 ks
MERX0016	Svorka WAGO 222-413	4,0 ks
MERX0027	Trubička smršť. 3,2/1,6 SB/PBF-1/8	0,05 m
MERX0029	Dutinka lisov. DI 1,5-10	24,0 ks
MERX0030	Objímka plochá RF-F 608P	12,0 ks
MERX0051	Vývodka PG 9 s matkou	16,0 ks
MERX0067	Přichytka PKB-BS 27x27mm přírodní samolepící	3,0 ks
MERX0069	Dutinka lis. DI 0,5-10	4,0 ks
MERX0073	Svorka WAGO 222-415	1,0 ks
MERX0078	Štítek uzemění malý /baleno po 40 ks/	4,0 ks
MERX0151	Spirála svazkovací SPC10	1,0 m
MERX0158	Pásek vázací 200/3,6	8,0 ks
MERX0205	Vývodka PG 7	9,0 ks
MERX0212	Dutinka lis. DI 0,25-8 -8	10,0 ks
MERX0221	Kolík ploch.přístroj. SEZC7202-00/4/100	5,0 ks
MERX0237	Konektor RJ 45-8/8 C5 dr vidlice	1,0 ks
MERX0282	Konektor RJ 45-8 Cat.5e UTP	1,0 ks
MERX0581	Filtr odrušovací MIFLEX FP-250/16	1,0 ks
MERX0631	Konektor 2,5 / 3 green SIGMATEK	16,0 ks
MERX0632	Konektor 1,5 / 2 green SIGMATEK	15,0 ks
MERX0633	Konektor 2,5 / 2 green SIGMATEK	1,0 ks
MERX0634	Konektor 2,5 / 4 green SIGMATEK	4,0 ks
MERX0635	Konektor 1,5 / 4 green SIGMATEK	1,0 ks
MERX0636	Konektor 1,5 / 3 green SIGMATEK	1,0 ks
MERX0646	Oko lisovací BF - M6	1,0 ks
MERX0648	Spirála svazkovací SPC15	0,5 m
MERX0661	Buž. smršť. SB 3,2/1,6 Mo modrá	0,06 m
MERX0662	Zástrčka ST18 -3 pol.č. Wieland	3,0 ks

KÓD	POPIS	MNOŽSTVÍ
METRO071	Deska základní HZS 521-G	1,0 ks
METRO072	Modul expandér HZS 532-1	1,0 ks
METRO083	Snímač teploty příložný KS 154A KTY 81-110, 3,5m	2,0 ks
METRO085	Snímač teploty TG8-55 KTY 81-110, 1,5m voda	1,0 ks
METRO087	Snímač teploty pro ven. KS 114B, KTY 81-110	1,0 ks
METRO108	Snímač teploty TR 050J-x TCK,silicon zelený 1,4m	1,0 ks
METRO197	Zásuvka kabel. NAC42S.B černá ENSTO	1,0 ks
MREZ0012	Etiketa stříbrná 210x297 baleno po 20 ks	0,25 ks
MRUZ0211	FlashDisk USB 2,0 Sandisk Cruzer Fit 8GB	1,0 ks
MRUZ0219	Průchodka 24,9 x 1,6 Moss 11214	1,0 ks
MRUZ0220	Podložka tlum. 10x10x2,5 čtvercová 35604-0	2,0 ks
MRUZ0272	Zátka antivibrační 1/2 BSP - velikost 8	1,0 ks
MRUZ0274	Zátka souběžná 46.1MM č.465668	2,0 ks
MRUZ0275	Fólie laminovací A4	1,0 ks
MRUZ0356	samolepka logo VERNER pryskyř. m50.0345	1,0 ks
MRUZ0481	Samolepka A 302 černá	1,0 ks
MTBX0033	Páska oboustranně lepící	0,02 ks
MRUZ0481	Samolepka A 302 černá	1,0 ks
MTBX0033	Páska oboustranně lepící	0,02 ks

PONAST spol. s r.o
Na Potůčkách 163
757 01 Valašské Meziříčí

ČESKÁ REPUBLIKA

www.ponast.cz

tel.: 571 688 111*, 800 700 068

e-mail: servis@ponast.cz

VERNER SK s.r.o
Klincová 37/b
821 08 Bratislava

SLOVENSKÁ REPUBLIKA

e-mail: kotle-verner@email.cz