



**katalog náhradních dílů**  
**automatického kotle**  
**KP 22S**

PONAST spol. s r.o  
Na Potůčkách 163  
757 01 Valašské Meziříčí  
ČESKÁ REPUBLIKA  
tel.: 571 688111\*  
e-mail: ponast@ponast.cz

aktualizace: 08/12/2018







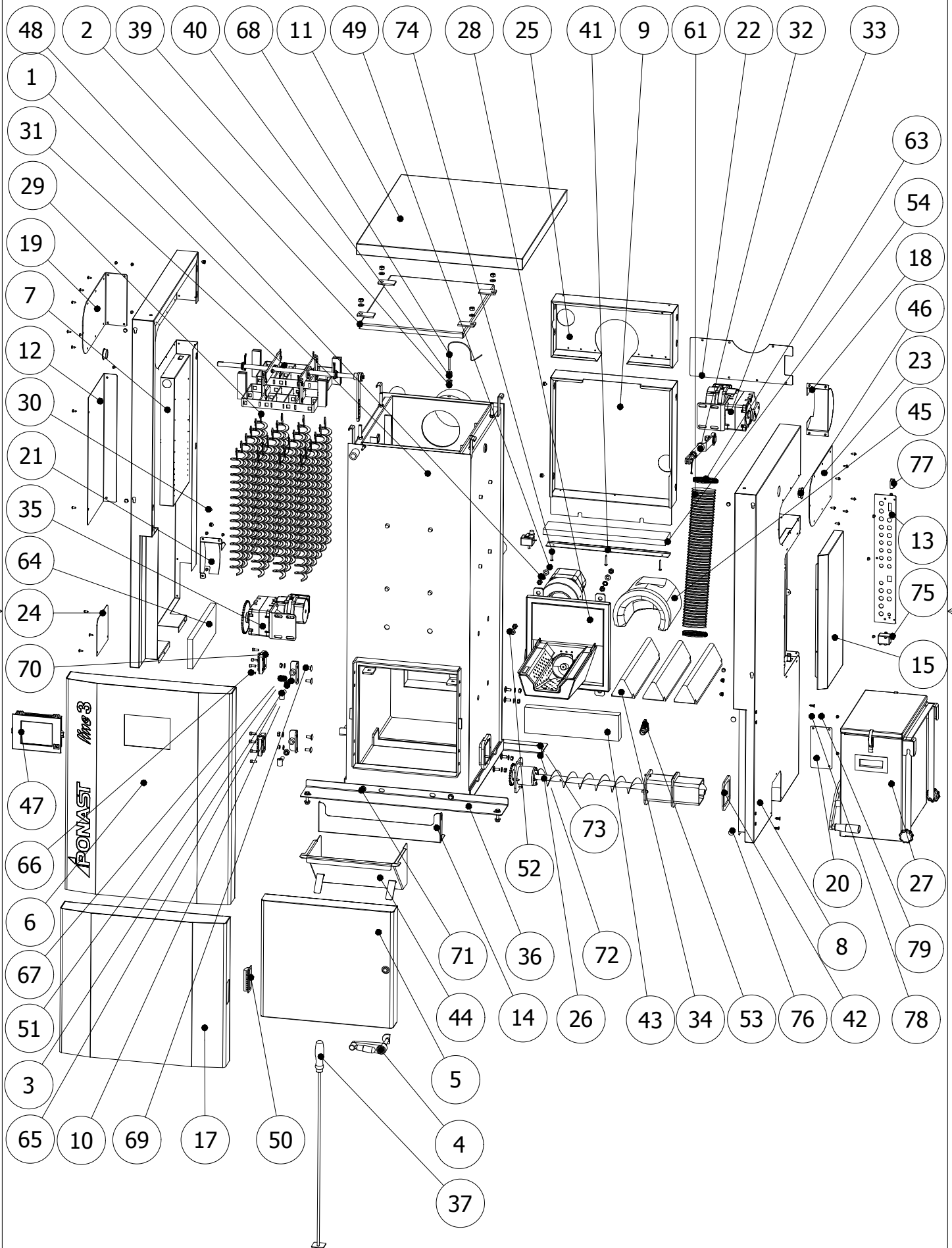





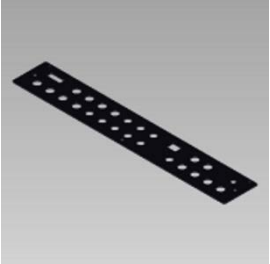

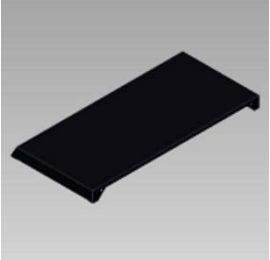
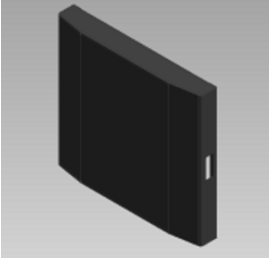
# KOTEL KP 22S



KOTEL KP22S	POZICE	POPIS	KÓD	ČÍSLO SOUČÁSTI	POZICE KS	POZNÁMKY
	1	TĚLESO KOTLOVÉ KP22	PKXX2201	397.S01.000.A1	1	Sestava
	2	VÍKO KOTL.TĚLESA KP20,21	KKTX0007	002.S02.000.A2	1	Sestava
	3	PANT DVÍŘEK	PKTX0121	054.S05.S03.A4	2	
	4	KLIKA x2	KKTX0019	338.S04.000.A3	1	Sestava
	5	DVÍŘKA	KKTX0029	397.S05.000.A2	1	Sestava
	6	ČELO KP22	PKMBB0146 PKMBB0393	727.S03.000.A3	1	NA PANTY NA ZÁMKY

KOTEL KP22S	POZICE	POPIS	KÓD	ČÍSLO SOUČÁSTI	POZICE KS	POZNÁMKY
	7	BOČNICE LEVÁ	PKMD0126 PKMD0385	726.S01.000.A3	1	NA PANTY NA ZÁMKY
	8	BOČNICE PRAVÁ	PKMD0132 PKMD0386	726.S02.000.A3	1	
	9	KRYT ZADNÍ SPODNÍ	PKMD0093	397.S10.002.A3	1	
	10	PANT DÍL 2	PKTX0134	397.S01.S43.A3	2	
	11	VÍKO HORNÍ- SVAŘENEC	PKMBB0151	727.S05.000.A4	1	
	12	KRYT KRABICE	PKMD0168	723.008.000.A3	1	

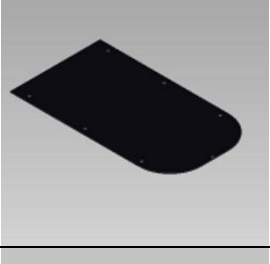
KOTEL KP22S	POZICE	POPIS	KÓD	ČÍSLO SOUČÁSTI	POZICE KS	POZNÁMKY
	13	DESKA	PKMD0143	723.005.000.A4	1	
	14	VZPĚRA	PKMD0359	727.SA6.000.A4	1	
	15	KRYT JEDNOTKY BOČNÍ	PKMD0142	726.008.000.A3	1	
	17	KRYT DVEŘÍ KP22	PKMBB0149	727.S04.000.A3	1	
	18	KRYT ČISTĚNÍ	PKMD0081	397.S13.000.A3	1	
	19	KRYTKA POHONU ČISTĚNÍ 2	PKMD0073	397.S07.008.A3	1	

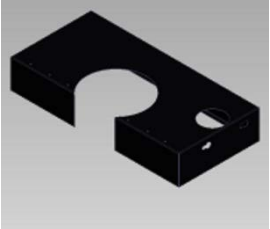
KOTEL KP22S	POZICE	POPIS	KÓD	ČÍSLO SOUČÁSTI	POZICE KS	POZNÁMKY
	20	PLECH KRYCÍ	PKMD0074	397.S07.009.A4	1	
	21	KRYT VYMETÁNÍ L+P	PKMD0062 PKMD0083	397.S14.000.A3	1	PRAVÝ LEVÝ
	22	ZAPLÁTOVÁNÍ	PKMD0089	397.015.000.A3	1	
	23	KRYTKA POHONU ČISTĚNÍ	PKMD0071	397.S07.006.A3	1	
	24	KRYTKA POHONU VYMETÁNÍ 1	PKMD0105	338.S06.005.A3	1	
	25	KRYT ZADNÍ HORNÍ	PKMD0094	397.S10.001.A3	1	





KOTEL KP22S	POZICE	POPIS	KÓD	ČÍSLO SOUČÁSTI	POZICE KS	POZNÁMKY
	26	VYMET.POPELE KP22	KKTX0032	398.000.000.A3	1	Sestava
	27	POPELNICE 30L	KKTIO046 KKTIO047	664.000.000.A3	1	Sestava PRAVÁ LEVÁ
	28	HOŘÁK KP51 L EPO	KHXX5126	523.V15.000.A3	1	Sestava
	29	TURBULÁTOR PLOCHÝ 460mm	MRUZ0016	054.016.000.A4	24	
	30	KLÍČ	PKRX0008	286.000.000.A4	16	
	31	ČISTĚNÍ VÝMĚNÍKU KP22	KKTX0063	796.000.000.A3	1	Sestava







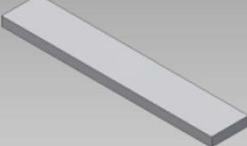
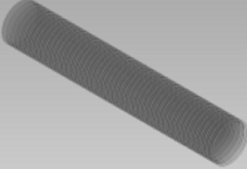

KOTEL KP22S	POZICE	POPIS	KÓD	ČÍSLO SOUČÁSTI	POZICE KS	POZNÁMKY
	32	MECHANISMUS ČISTĚNÍ	KKTX0024	424.000.000.A3	1	Sestava
	33	POHON ČISTĚNÍ TAHŮ	KKTX0041	727.S25.000.A3	1	Sestava
	34	KERAMIKA TROJÚHELNÍKOVÁ	MTKE0135	420.900.000.A3	3	
	35	POHON VYMETÁNÍ	KKTX0039	727.S24.000.A3	1	Sestava
	36	DRŽÁK KOTLE	PKRX0006	005.017.000.A3	2	
	37	ŠKRABKA	PKRX0001	001.S32.000.A4	1	

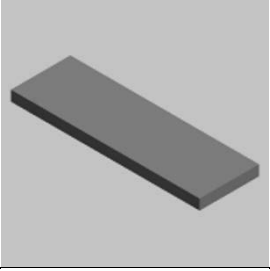
KOTEL KP22S	POZICE	POPIS	KÓD	ČÍSLO SOUČÁSTI	POZICE KS	POZNÁMKY
	39	REDUKCE DÍL 1	PKRX0062	792.001.000.A4	1	
	40	REDUKCE DÍL 2	PKRX0063	792.002.000.A4	1	
	41	DRŽÁK SIBRALU	PKMD0095	397.058.000.A4	1	
	42	TĚSNĚNÍ	PKTX0157	334.S08.005.A4	1	
	43	KERAMIKA NAD DVÍŘKA KP21	MTKE0006	054.021.000.A4	1	
	44	LOPATKA KP22	PKTX0222	398.S09.000.A3	1	

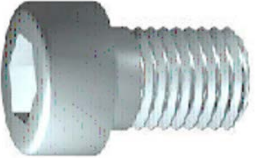
KOTEL KP22S	POZICE	POPIS	KÓD	ČÍSLO SOUČÁSTI	POZICE KS	POZNÁMKY
	45	REFLEKTOR KERAMICKÝ	MTKE0020		1	
	46	ZÁSLEPKA ČERNÁ 35-38mm	MRUZ0228		2	
	47	TERMINÁL DOTYKOVÝ HZS 555-S	METR0073		1	
	48	Vějířová pojistná podložka - A 10,5	MSPX0003	DIN 6798	2	
	49	Šestihranné matice - M10	MSMX0041	ISO 4032	10	
	50	Rukojeť EPR_90_Pf_C1	MRUZ0205		1	

KOTEL KP22S	POZICE	POPIS	KÓD	ČÍSLO SOUČÁSTI	POZICE KS	POZNÁMKY
	51	Ploché podložky - 8	MSPX0001	ISO 7089	24	
	52	Ploché podložky - 10	MSPX0005	ISO 7089	8	
	53	VENTIL VYPOŠTĚCÍ S PÁČKOU	MRUZ0024		1	
	54	SIBREX 300 20x80x452	MTIZ0019		1	
	61	HADICE FLEXADUR PU-1NO DN 80x1000	MRUZ0018		1	
	63	SPONA HADICOVÁ 70-90 NEREZ	MRUZ0089		2	

KOTEL KP22S	POZICE	POPIS	KÓD	ČÍSLO SOUČÁSTI	POZICE KS	POZNÁMKY
	64	SIBREX 20x115x365	MTIZ0009	SIBREX 20x115x365	1	
	65	Šestihřanné matice - M12	MSMX0007	ISO 4032	2	
	66	Šroub s válcovou hlavou - M6 x 16	MSSX0224	DIN 912	8	
	67	Šestihřanné matice - M8	MSMX0016	ISO 4032	28	
	68	Snímač teploty TR 050J-x TCK, 1,4m	METRO108		1	
	69	Šroub vratový - M8 x 20	MSSX0024	ISO 8678	8	

KOTEL KP22S	POZICE	POPIS	KÓD	ČÍSLO SOUČÁSTI	POZICE KS	POZNÁMKY
	70	Pant ELESA CFA.65-SL-H-V	PKTX0295		2	
	71	Šestihranný šroub - M8 x 20	MSSX0002	DIN 933	4	
	72	Šestihranný šroub - M8 x 40	MSSX0027	DIN 933	4	
	73	Podložka - A 10,5	MSPX0005	DIN 125	12	
	74	Šroub do plechu - ST4,8 x 38	MSSX0042	ISO 7049	3	
	75	HAVARIJNÍ TERMOSTAT LY 26 I	METRO049		2	

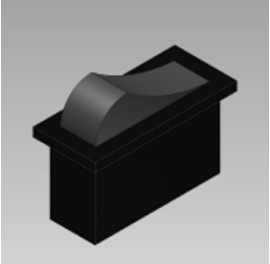
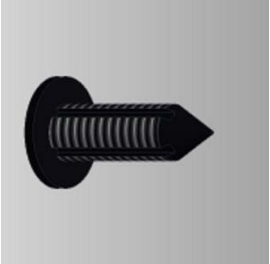
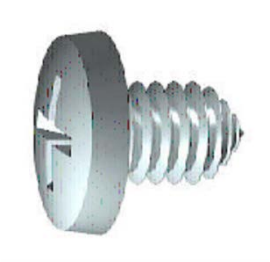
KOTEL KP22S	POZICE	POPIS	KÓD	ČÍSLO SOUČÁSTI	POZICE KS	POZNÁMKY
	76	MAGNET 18x2	MRUZ0077		2	
	77	Vypínač SSk 315 RED	MERX0579		1	
	78	Nýt zarážecí pr.5mm 27024050	MSSX0125		4	
	79	Šrouby samořezné - ST 4,8 x 13	MSSX0118	ISO 7049	47	

# TĚLESO KOTLOVÉ KP 22

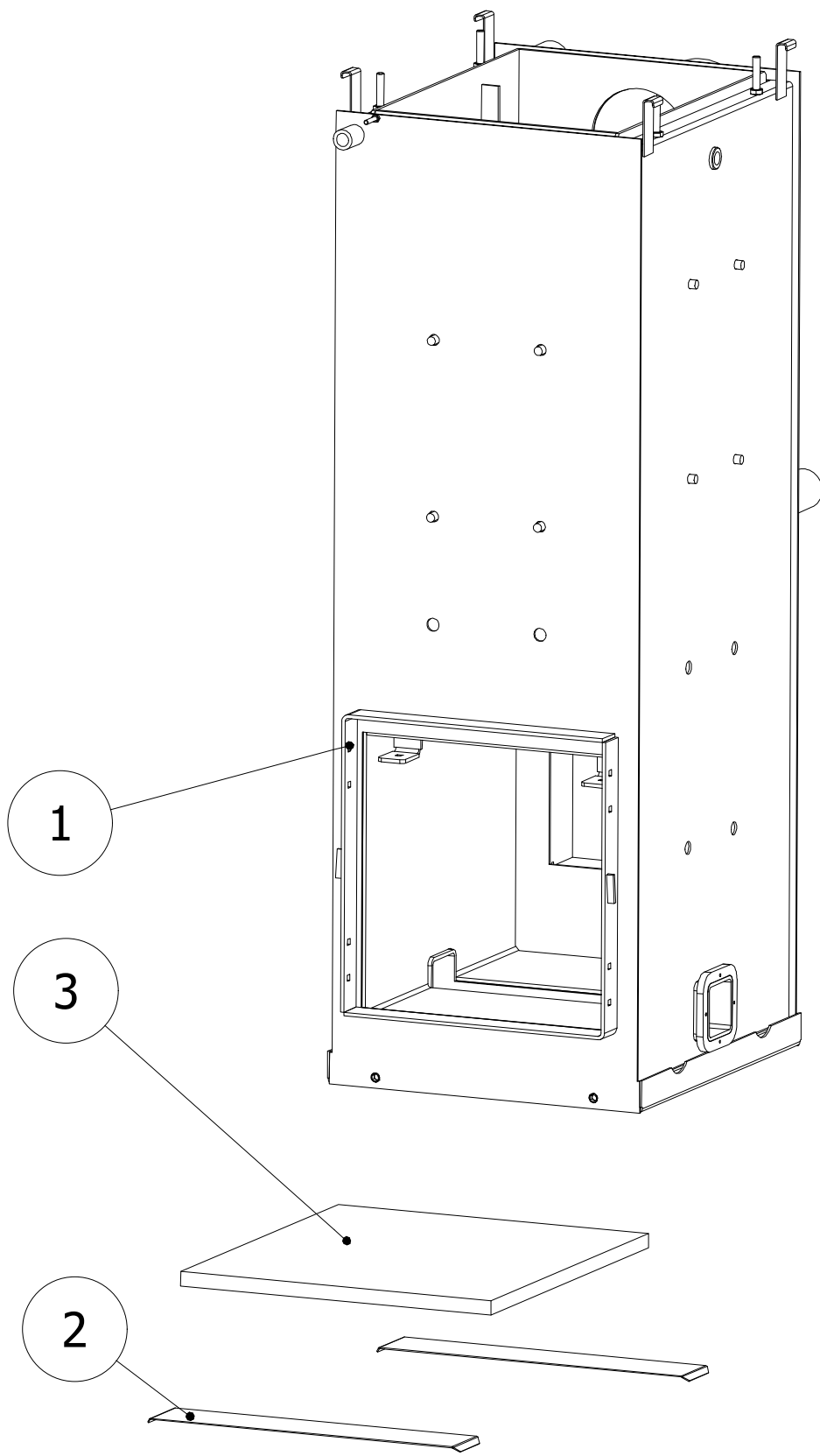



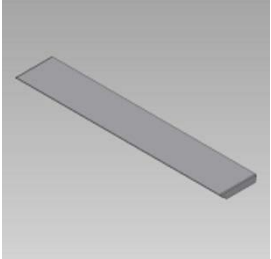
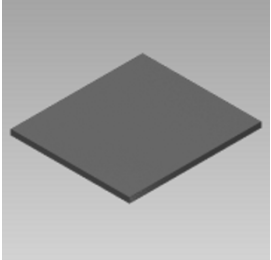

TĚLESO KOTLOVÉ KP22S	POZICE	POPIS	KÓD	ČÍSLO SOUČÁSTI	POČET KS	POZNÁMKY
	1	TĚLESO KOTLOVÉ KP22S	PKXX2201	397.S01.000.A1	1	
	2	DRŽÁK IZOLACE KP21,KP22	PKTX0347	PKTX0347	2	
	3	IZOLACE 20x515x464	PKTX0343		1	

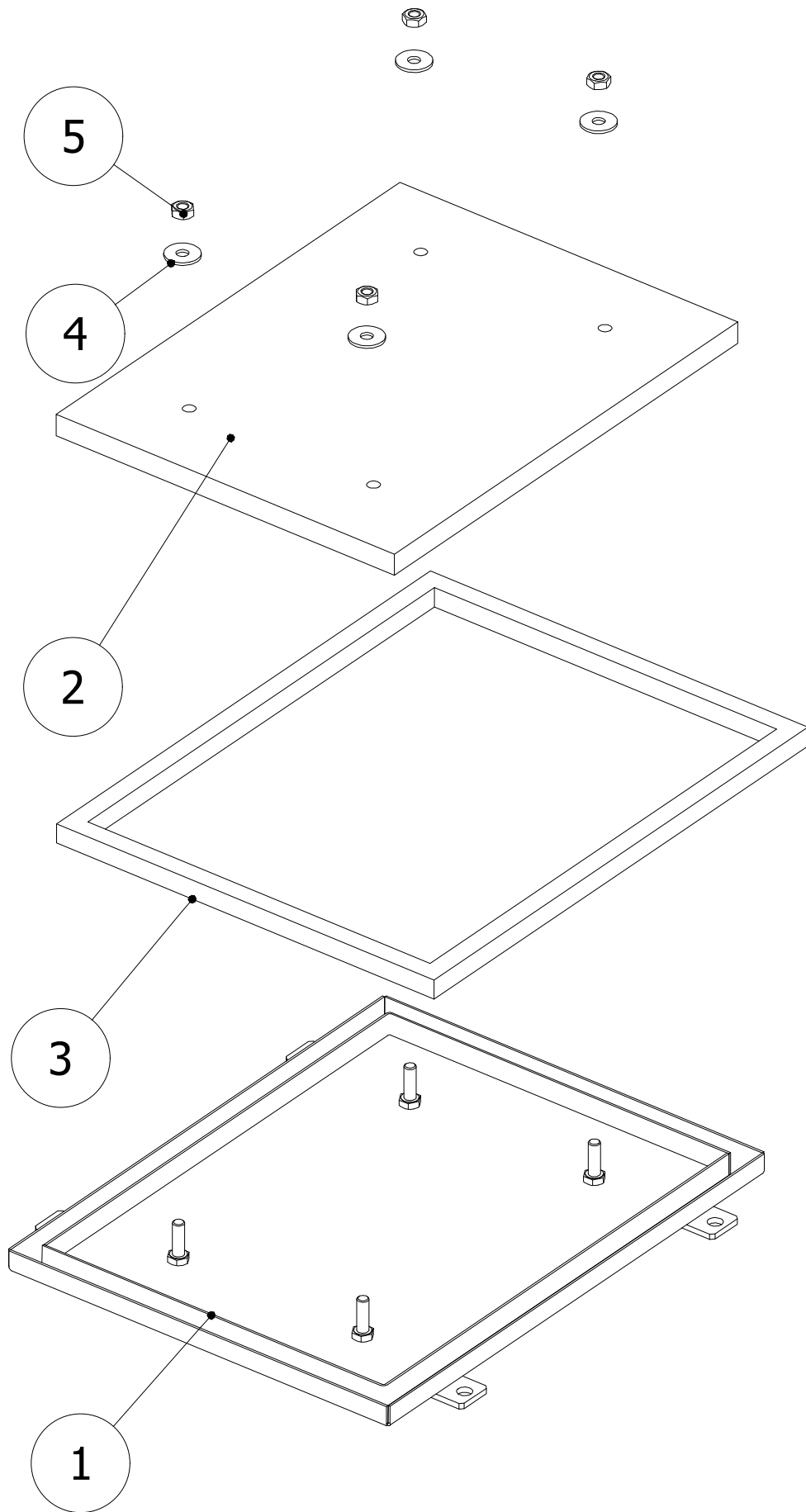
VÍKO

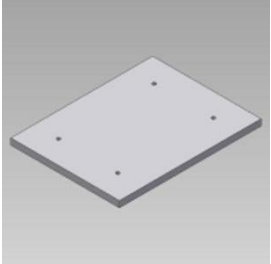
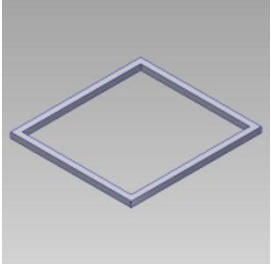

Víko	POZICE	POPIS	KÓD	ČÍSLO SOUČÁSTI	POČET KS	POZNÁMKY
	1	VÍKO KOTL.TĚLESA KP20,21	PKTX0072	001.002.000.A2	1	
	2	SIBREX 140 20x345x446	MTIZ0002		1	
	3	ŠŇŮRA TĚSN. 18x18	MRUZ0133		1.52m	
	4	Podložka - 10,5	MSPX0004	DIN 9021	4	Zn
	5	Šestihránná matice - M10	MSMX0002	DIN 934	4	Zn

KLIKA

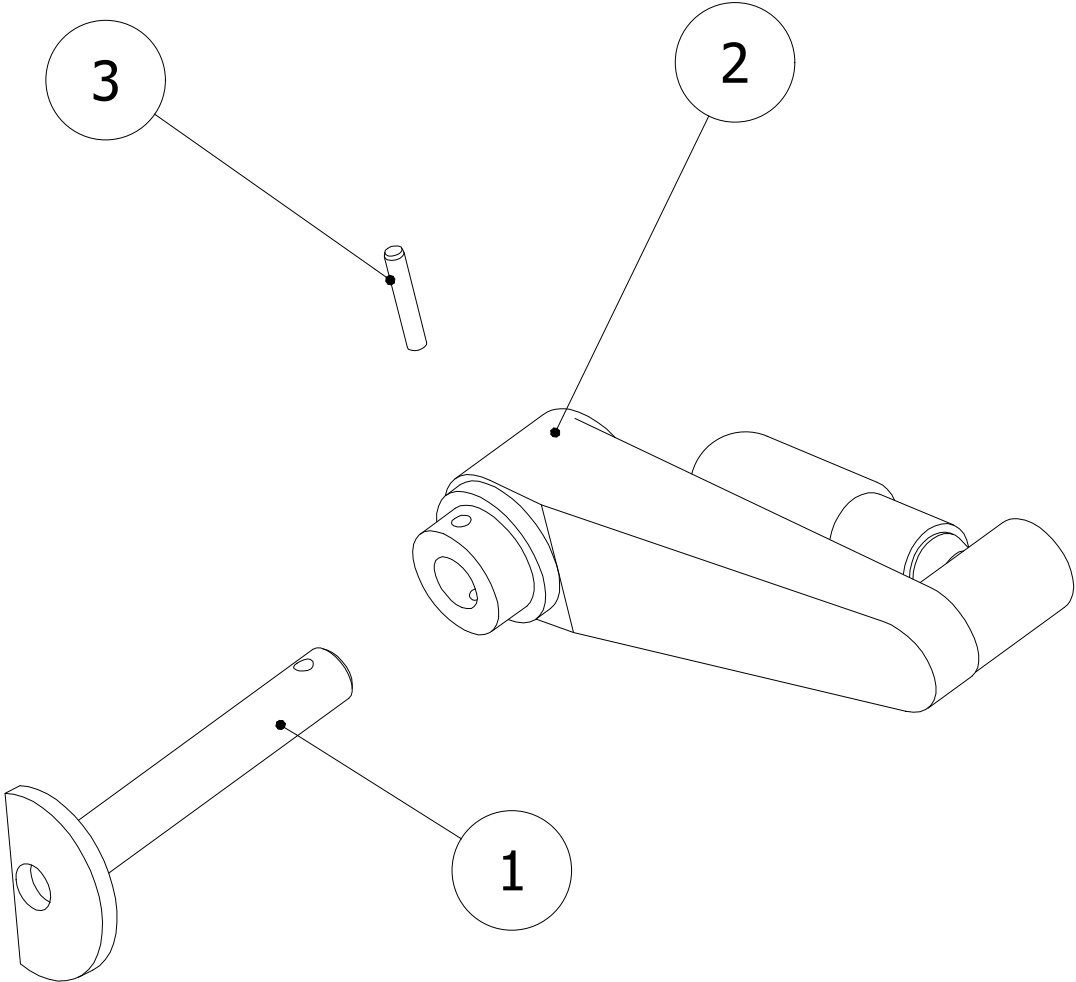

KLIIKA	POZICE	POPIS	KÓD	ČÍSLO SOUČÁSTI	POČET KS	POZNÁMKY
	1	DŘÍK KLIKY	PKTX0118	054.S04.001.A3	1	
	2	KLIIKA SKLAPOVACÍ ELESA GANTER	MRUZ0117	MT.100-AT+IR	1	KÓD 44317
	3	Kolík - 4 x 24 - A (kalený)	MSRX0003	ISO 8734	1	

DVÍŘKA

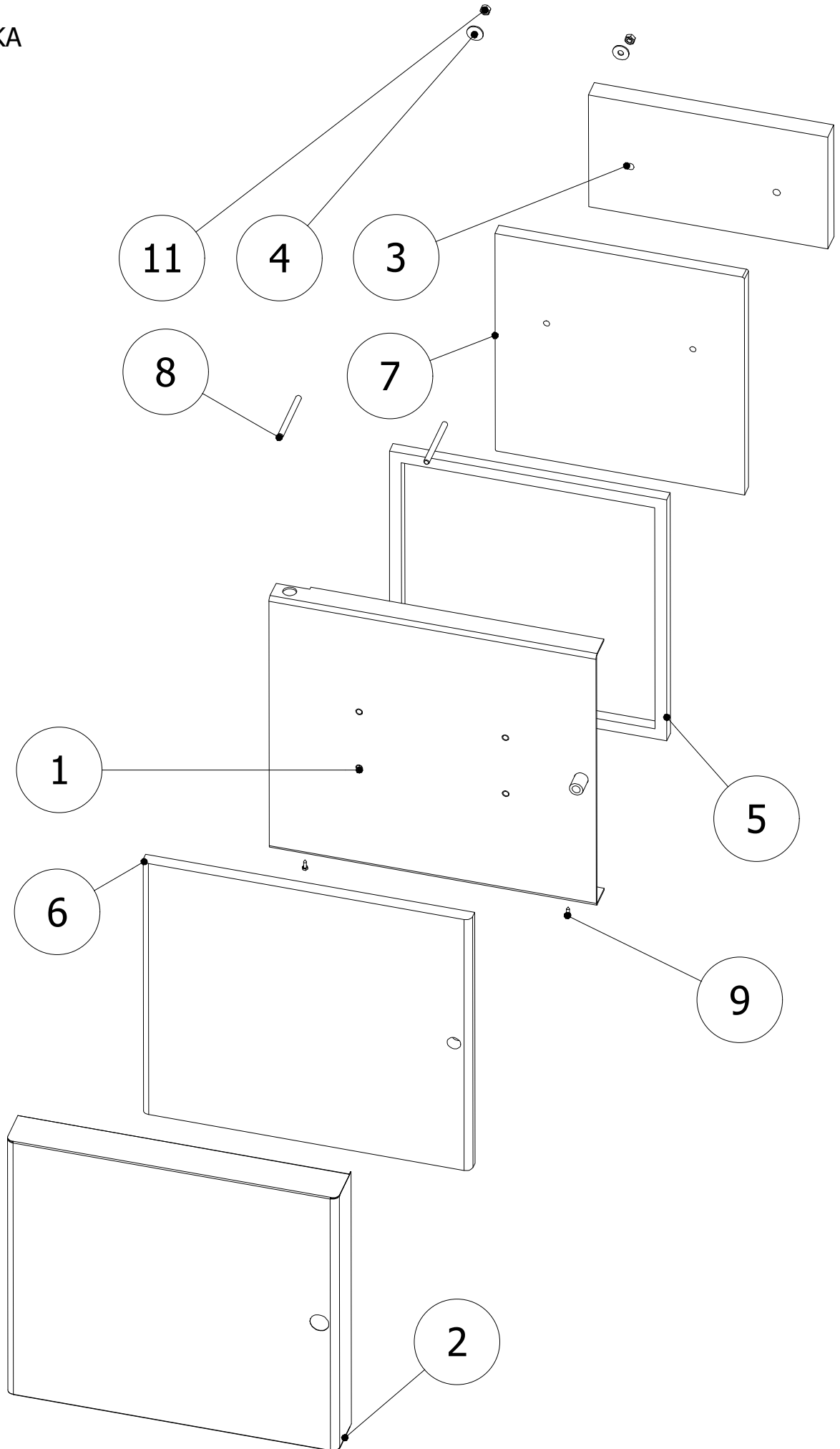

DVÍŘKA	POZICE	POPIS	KÓD	ČÍSLO SOUČÁSTI	POČET KS	POZNÁMKY
	1	DVÍŘKA KP22	PKTX0211	397.005.000.A3	1	
	2	KRYT DVÍŘEK	PKMD0090	397.012.000.A3	1	
	3	KERAMIKA NA DVÍŘKA	MTKE0004	001.005.008.A4	1	
	4	Podložka - 8,4	MSPX0008	DIN 9021	2	
	5	TĚSN. ŠŇŮRA 18x18	MRUZ0133		1.62m	
	6	IZOLACE DVÍŘEK 20x469x449	MTIZ0011		1	

DVÍŘKA	POZICE	POPIS	KÓD	ČÍSLO SOUČÁSTI	POČET KS	POZNÁMKY
	7	IZOLACE TĚLA 20x388x370	MTIZ0005		1	
	8	TYČ ZÁVITOVÁ M8x95	PKTX0117		2	
	9	Šroub do plechu - ST4,2 x 13	MSSX0012	ISO 1479	2	
	10	NÝT 10x50 Fe	MSRX0032	DIN 660	2	
	11	Šestihrná matice - M8	MSMX0016	ISO 4032	2	



# VYMETÁNÍ POPELE

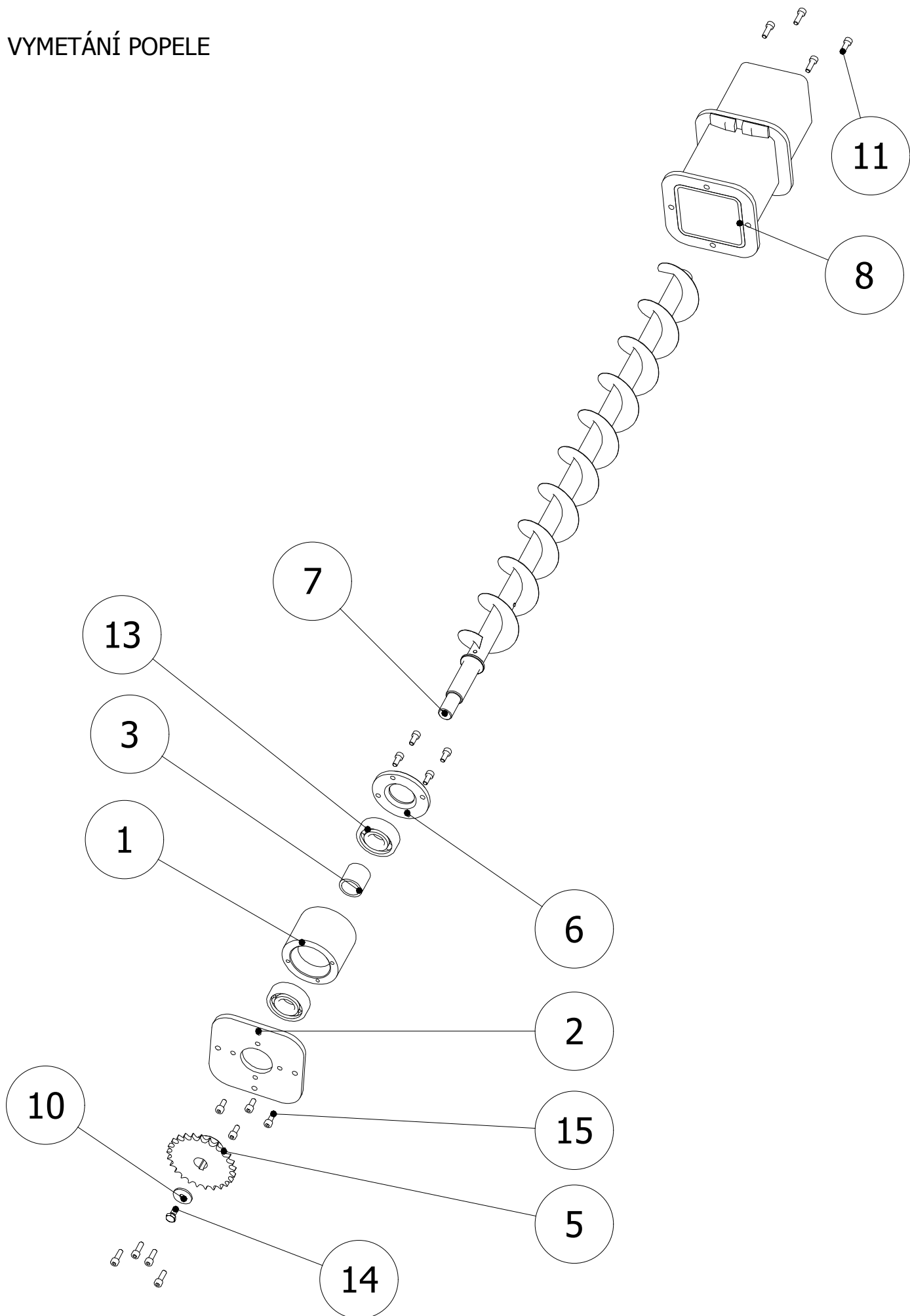



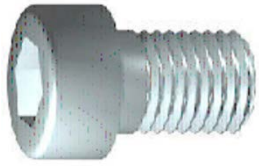

Vymetání popele KP22	POZICE	POPIS	KÓD	ČÍSLO SOUČÁSTI	POZICE KS	POZNÁMKY
	1	NÁBOJ	PKTX0140	334.001.000.A4	1	
	2	VÍKO 1	PKTX0150	334.002.000.A4	1	
	3	DISTANCE	PKTX0440	334.003.000.A4	1	
	5	KOLO ŘETĚZOVÉ S NÁB.3/8"x7/32"	PKTX0143	334.005.000.A4	1	
	6	VÍKO 2	PKTX0144	334.006.000.A4	1	
	7	ŠNEK	PKTX0219	398.S07.000.A3	1	

Vymetání popele KP22	POZICE	POPIS	KÓD	ČÍSLO SOUČÁSTI	POZICE KS	POZNÁMKY
	8	VEDENÍ ŠNEKU	PKTX0153	334.S08.000.A3	1	
	10	Podložka 6	MSPX0002	DIN 440R	1	
	11	Šroub s válcovou hlavou - M5 x 16	MSSX0055	DIN 912	8	
	12	Těsné pero - A 5 x 5 x 22	MSRX0006	DIN 6885	1	
	13	Kuličková ložiska jednořadá - 6204 2Z	MRUZ0049	CSN 02 4630	2	
	14	Šestihrný šroub - M6 x 10	MSSX0019	DIN 933	1	Zn

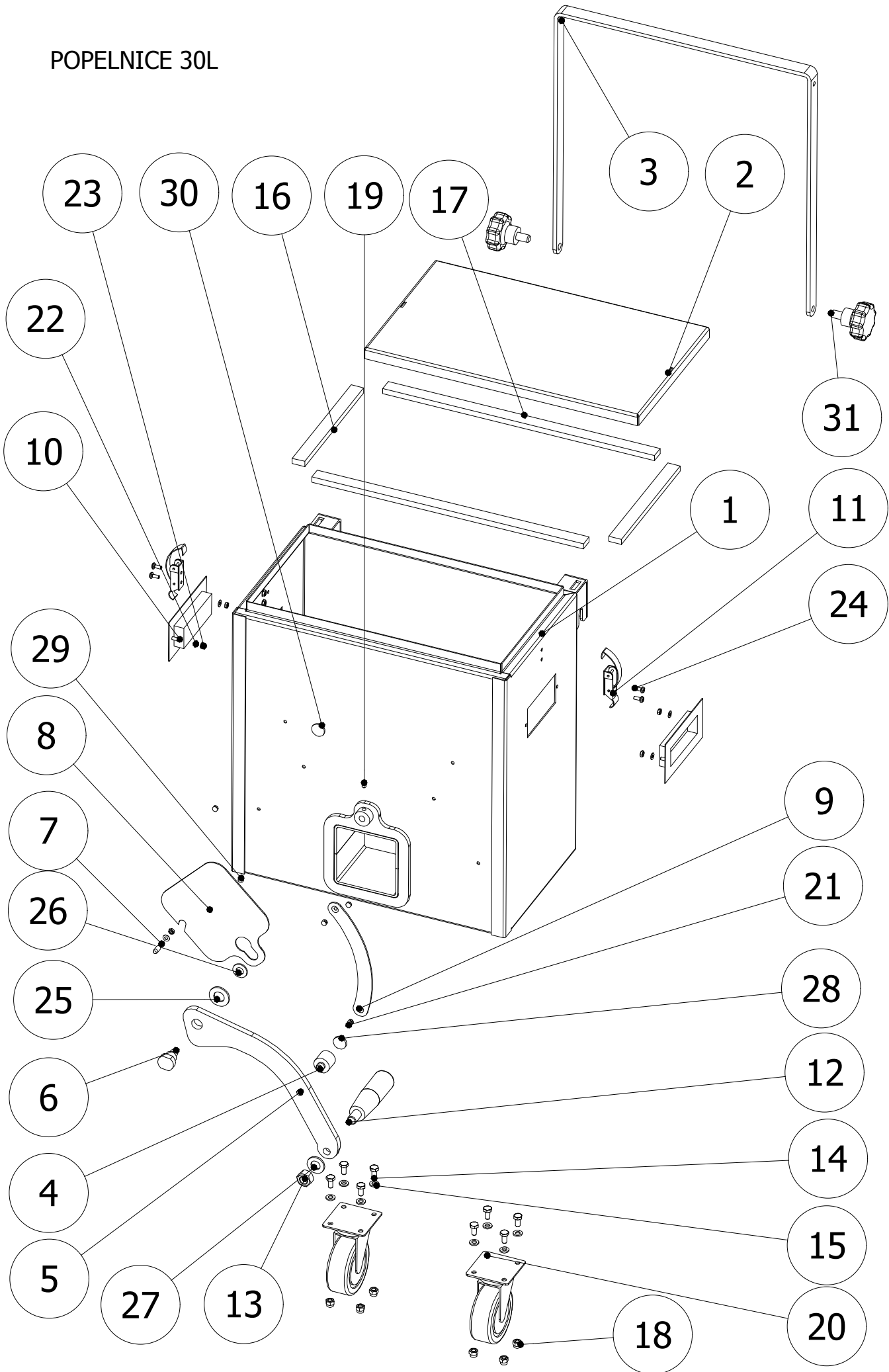
Vymetání popele KP22	POZICE	POPIS	KÓD	ČÍSLO SOUČÁSTI	POZICE KS	POZNÁMKY
	15	Šroub s válcovou hlavou - M5 x 12	MSSX0137	DIN 912	8	

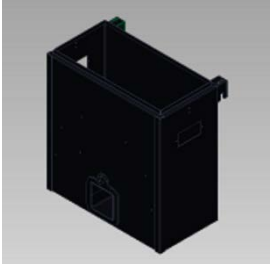
POPELNICE 30L

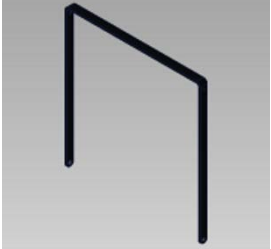
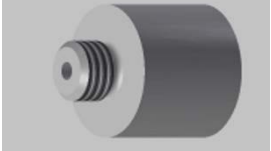

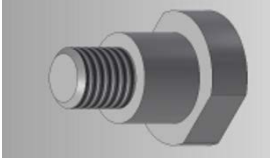
POPELNICE 30L	POZICE	POPIS	KÓD	ČÍSLO SOUČÁSTI	POČET KS	POZNÁMKY
	1	POPELNICE 30L KRABICE	PKTD0274	664.S01.000.A3	1	
	2	VÍKO	PKTB0281	664.S02.000.A3	1	
	3	DRŽADLO	PKTD0282	664.003.000.A3	1	
	4	DRŽÁK MAGNETICKÝ	PKTX0198	448.009.000.A4	1	
	5	PÁKA	PKTD0283	664.005.000.A3	1	
	6	ŠROUB	PKTX0197	448.006.000.A4	1	

POPELNICE 30L	POZICE	POPIS	KÓD	ČÍSLO SOUČÁSTI	POČET KS	POZNÁMKY
	7	DISTANCE	PKMX0037	054.009.003.A4	1	
	8	ZÁKLOPKA	MHVT0186	448.012.000.A4	1	
	9	DRÁHA	PKTX0284	664.010.000.A4	1	
	10	ÚCHYTKA ZAPUŠTĚNÁ UWAUNS	MRUZ0200	ÚCHYT	2	
	11	UZÁVĚR UP3	MRUZ0010		2	
	12	DLOUHÁ KUŽ. RUKOJEŤ	MRUZ0062	OBJ.Č.460650	1	

POPELNICE 30L	POZICE	POPIS	KÓD	ČÍSLO SOUČÁSTI	POČET KS	POZNÁMKY
	13	Šestihránné matice - M12	MSMX0007	ISO 4032	1	
	14	Šrouby se šestihránnou hlavou - M6 x 12	MSSX0083	ISO 4017	8	
	15	Ploché podložky - 6	MSPX0026	ISO 7089	8	
	16	TĚSNĚNÍ SILIKONOVÉ 8x18-190	MRUZ0090		2	
	17	TĚSNĚNÍ SILIKONOVÉ 8x18-386	MRUZ0201		2	
	18	Samojistné šestihránné matice - M6	MSMX0011	ISO 7041	8	



POPELNICE 30L	POZICE	POPIS	KÓD	ČÍSLO SOUČÁSTI	POČET KS	POZNÁMKY
	19	Stavěcí šrouby - M5 x 10	MSRX0015	ISO 4027	1	
	20	KOLO PEVNÉ EGA 075/FLP PR.75	MRUZ0056	FA.MONTAKO	2	
	21	Nýt se záp.hl. 4x8 Al	MSRX0064	DIN 660	2	
	22	Ploché podložky - 4	MSPX0014	ISO 7089	9	
	23	Šestihranné matice - M4	MSSX0012	ISO 4032	9	
	24	Šrouby s válcovitou hlavou5 - M4 x 10	MSSX0010	ISO 7045	4	

POPELNICE 30L	POZICE	POPIS	KÓD	ČÍSLO SOUČÁSTI	POČET KS	POZNÁMKY
	25	Ploché podložky - 14	MSPX0007	ISO 7089	1	
	26	Ploché podložky - 10	MSPX0005	ISO 7089	1	
	27	Ploché podložky - 12	MSPX0020	ISO 7089	1	
	28	MAGNET 18x3	MRUZ0088		1	
	29	Nýt trhací 4 x 8 Al	MSRX0013	DIN 660	3	
	30	MAGNET 18x2	MRUZ0077		1	

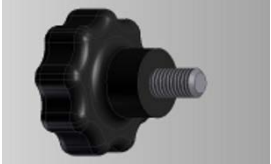

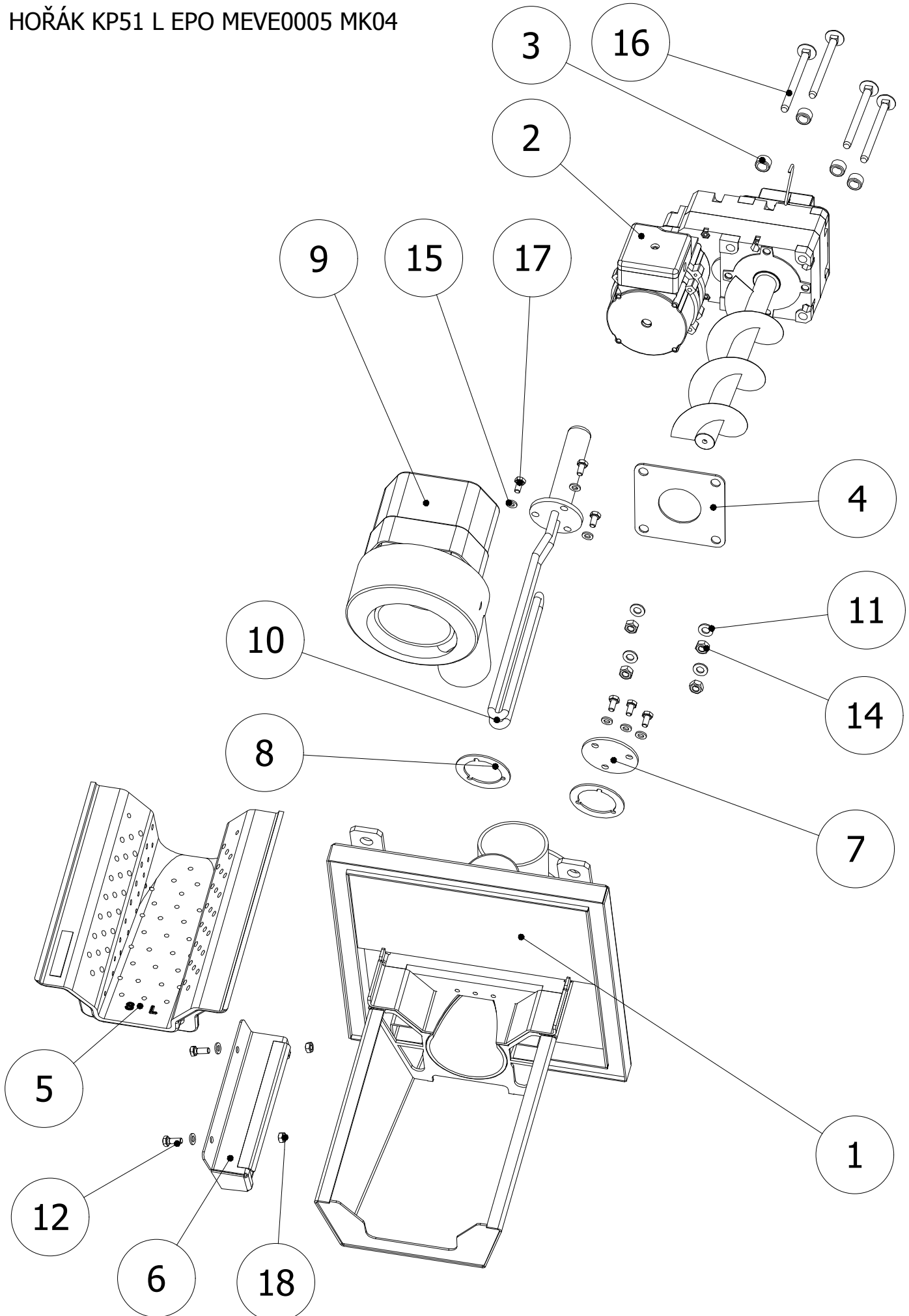

POPELNICE 30L	POZICE	POPIS	KÓD	ČÍSLO SOUČÁSTI	POČET KS	POZNÁMKY
	31	ŠROUB KOVOVÝ S PLAST.HLAVOU M10x17	MRUZ0032	OBJ.Č.105a- 068-D/MxL	2	

HOŘÁK KP51 L EPO MEVE0005 MK04

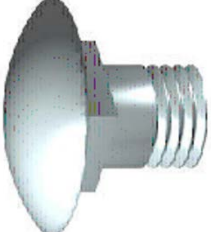
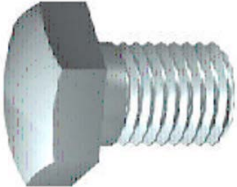

HOŘÁK KP51 L EPO MEVE0005 MK04	POZICE	POPIS	KÓD	ČÍSLO SOUČÁSTI	POČET KS	POZNÁMKY
	1	HOŘÁK KP51 SVAŘENEC+TĚSNĚNÍ+ SIBREX	KHXX5102	523.001.000.A3	1	Sestava
	2	PODAVAČ P2 EPO 2013	KHXX5125	523.S21.000.A3	1	Sestava
	3	DISTANCE DRŽÁKU SNÍMAČE	PHXX0162	428.400.000.A4	4	
	4	MEZIKUS PRO EPOMOTORY 2013	PHXX0161	428.300.000.A4	1	
	5	DESKA HOŘÁKOVÁ KP51	MHRX0052	523.050.000.A3	1	
	6	TUNEL	PHXX0062	523.014.000.A3	1	

HOŘÁK KP51 L EPO MEVE0005 MK04	POZICE	POPIS	KÓD	ČÍSLO SOUČÁSTI	POČET KS	POZNÁMKY
	7	VÍČKO	PHXX0113	116.018.000.A4	1	
	8	TĚSNĚNÍ	PHXX0115	493.021.000.A4	2	
	9	VENTILÁTOR RLG 97	MEVE0005		1	
	10	SPIRÁLA ZAPALOVACÍ 1000W ZALOM.	MERX0139		1	
	11	Ploché podložky - 8	MSPX0001	ISO 7089	4	
	12	Šestihranný šroub - M6 x 16	MSSX0015	DIN 933	2	

HOŘÁK KP51 L EPO MEVE0005 MK04	POZICE	POPIS	KÓD	ČÍSLO SOUČÁSTI	POČET KS	POZNÁMKY
	14	Šestihránné matice - M8	MSMX0016	ISO 4032	4	
	15	Ploché podložky – 6.4	MSPX0026	ISO 7089	8	
	16	Šroub s půlk.hl.a 4rh.krčkem - M8 x 100	MSSX0129	DIN 603	4	
	17	Šrouby se šestihránnou hlavou - M6 x 12	MSSX0083	ISO 4017	6	
	18	Šestihránné matice - M6	MSMX0001	ISO 4032	2	

# HOŘÁK KP51 SVAŘENEC+TĚSNĚNÍ+SIBREX

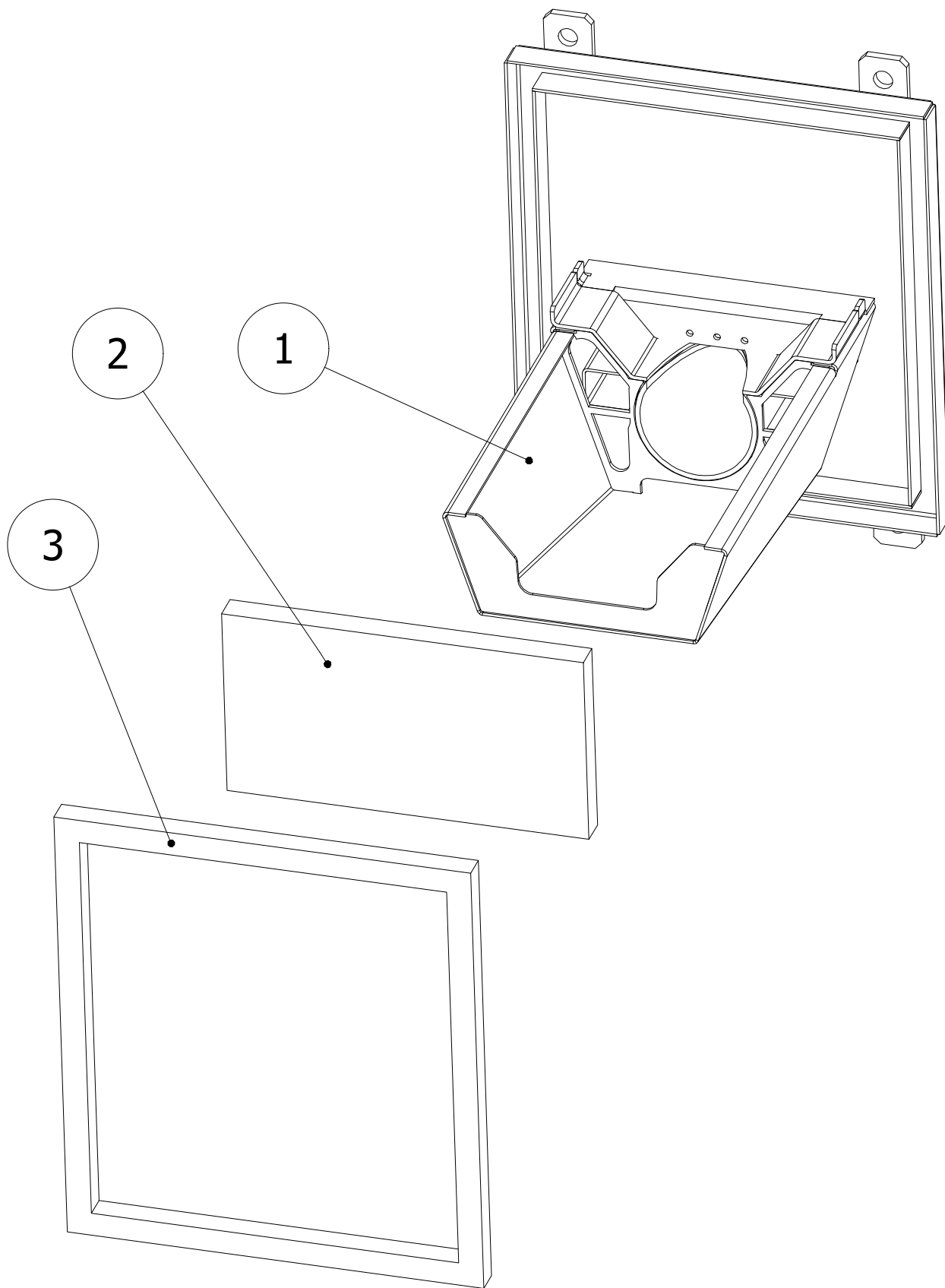



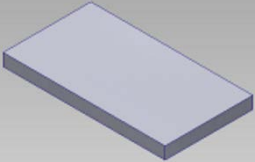
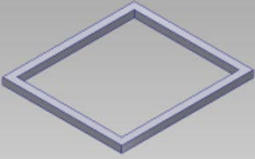



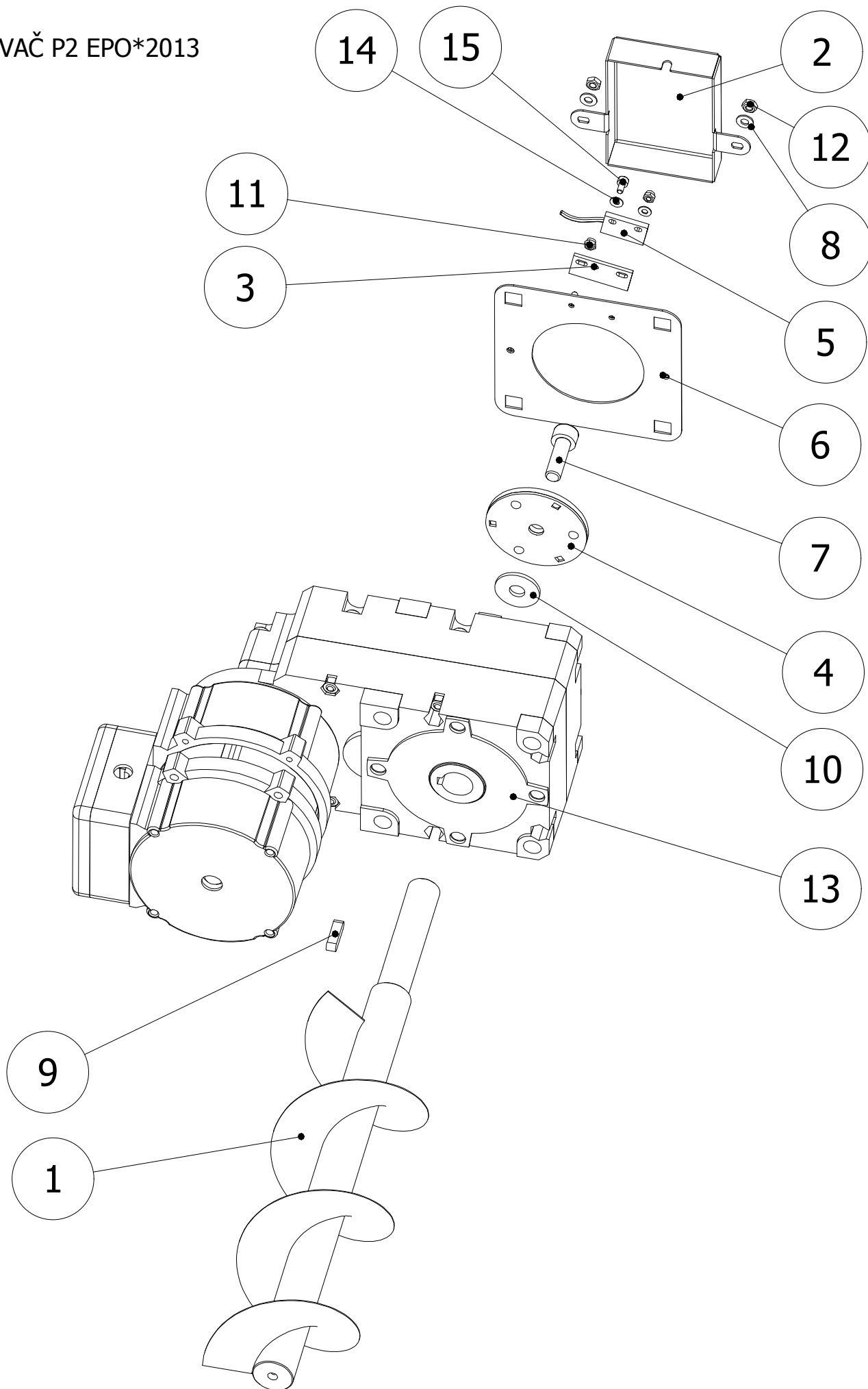

HOŘÁK KP51 SVAŘENEC+TĚSNĚNÍ+SIBREX	POZICE	POPIS	KÓD	ČÍSLO SOUČÁSTI	POZICE KS	POZNÁMKY
	1	HOŘÁK KP51- SVAŘENEC UNI	PHXX5101	523.S00.000.A3	1	
	2	SIBREX 300 20x142x260	MTIZ0003		1	
	3	Šňůra těsnící 18x18	MRUZ0133		1,26m	

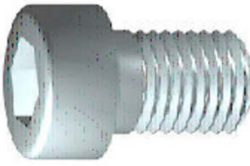
PODAVAČ P2 EPO\*2013

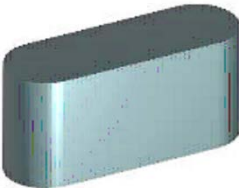

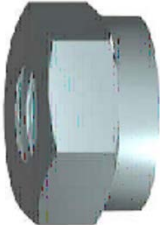
PODAVAČ P2 EPO*2013	POZICE	POPIS	KÓD	ČÍSLO SOUČÁSTI	POČET KS	POZNÁMKY
	1	ŠNEK KP51 ABM	PHXX0053	493.S19.000.A3	1	Délka 353,5mm
	2	KRABIČKA SNÍMAČE SIGMATEK	MHVH0115	786.000.000.A4	1	
	3	Adaptér pro MK04	PHXX0214	798.110.001.A4	1	
	4	KOLO SNÍMAČE MEDER MK04/EPO	PHXX0213	PHXX0213	1	
	5	Snímač MEDER MK04- 1A66-dl. 1900mm	MERX0777		1	
	6	DRŽÁK SNÍMAČE OTÁČEK	MHVH0119	428.100.000.A4	1	

PODAVAČ P2 EPO*2013	POZICE	POPIS	KÓD	ČÍSLO SOUČÁSTI	POČET KS	POZNÁMKY
	7	Šroub s válcovou hlavou - M8 x 25	MSSX0095	DIN 912	1	
	8	Ploché podložky - 4	MSPX0014	ISO 7089	2	
	9	Těsné pero 5e7 x 5 x 20	MSRX0005	DIN 6885	1	
	10	Podložka - 8,4	MSPX0008	DIN 9021	1	
	11	Šestihranná matice pojistná - M3	MSMX0024	DIN 985	2	
	12	Šestihranná matice - M4	MSSX0012	ISO 4032	2	

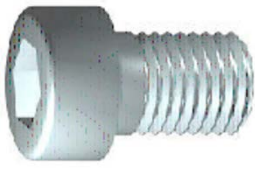
PODAVAČ P2 EPO*2013	POZICE	POPIS	KÓD	ČÍSLO SOUČÁSTI	POČET KS	POZNÁMKY
	13	Motor EPO MRB 0,06kW/4p	MEMP003 5		1	
	14	Ploché podložky - 3	MSPX0031	ISO 7089	2	
	15	Šroub s válcovou hlavou - M3 x 6	MSSX0226	DIN 912	1	



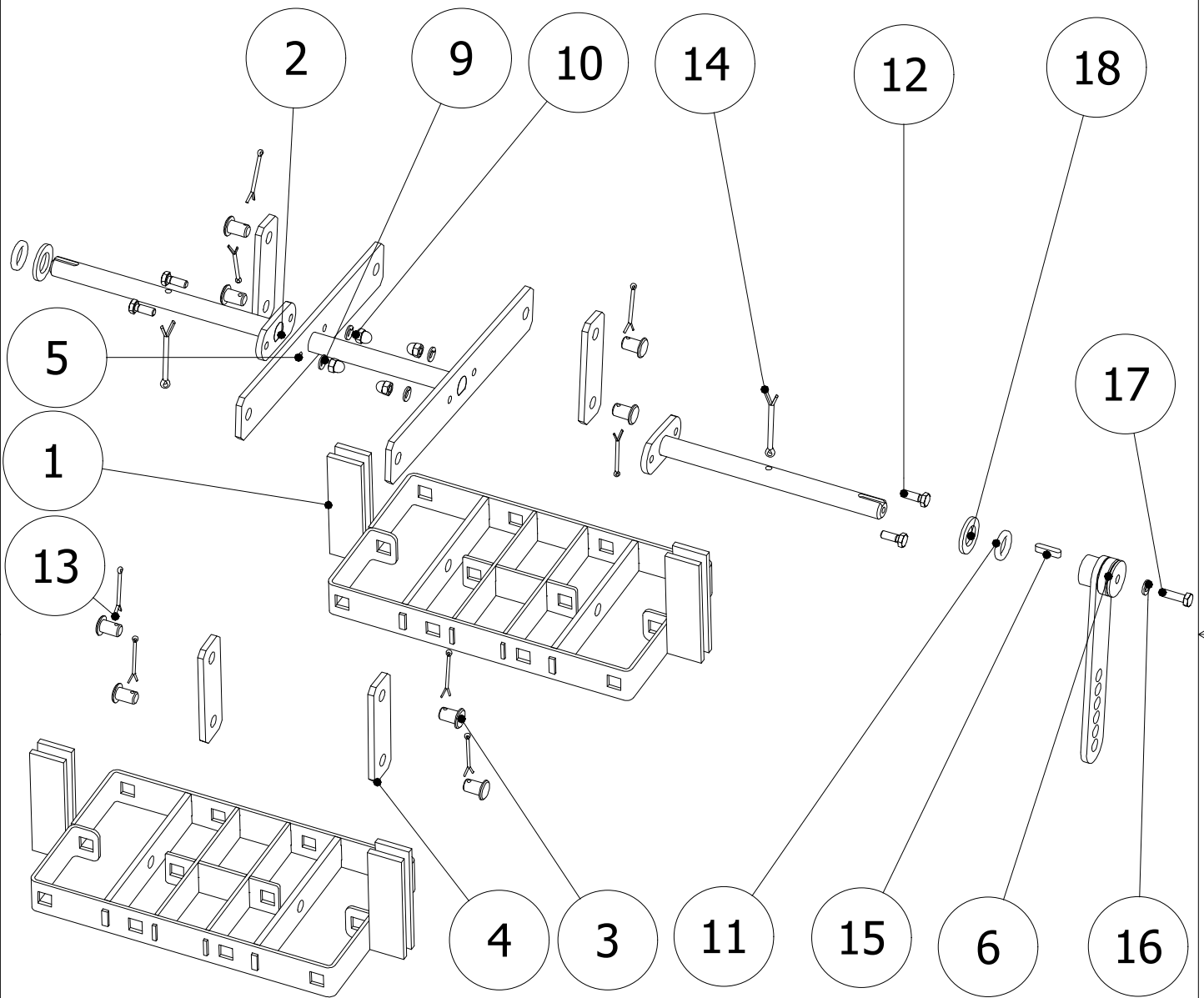

# ČISTĚNÍ VÝMĚNÍKU

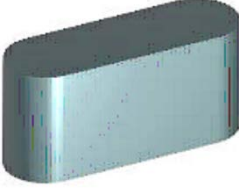

ČISTĚNÍ VÝMĚNÍKU	POZICE	POPIS	KÓD	ČÍSLO SOUČÁSTI	POČET KS	POZNÁMKY
	1	VAHADLO	PKTX0388	796.S01.000.A3	2	
	2	NÁSTAVEC	PKTX0387	796.S06.S00.A4	2	
	3	ČEP	PKTX0053	005.S16.007.A4	8	
	4	ZÁVĚS	PKTX0051	005.S16.004.A4	4	
	5	HŘÍDEL SPOJOVACÍ	PKTX0326	758.S06.A00.A3	1	
	6	RAMENO	PKTX0163	445.S08.000.A4	1	

ČISTĚNÍ VÝMĚNÍKU	POZICE	POPIS	KÓD	ČÍSLO SOUČÁSTI	POČET KS	POZNÁMKY
	9	Pružná podložka - A6	MSPX0019	DIN 128	4	
	10	Šestihranná matice uzavřená - M6	MSMX0027	DIN 1587	4	
	11	Šňůra těs. čistění 4x4	PKTX0432		2	
	12	Šestihranný šroub - M6 x 16	MSSX0015	DIN 933	4	
	13	Závlačka - 2,5 x 36	MSRX0048	ISO 1234	8	
	14	Závlačka - 4 x 50	MSRX0021	ISO 1234	2	

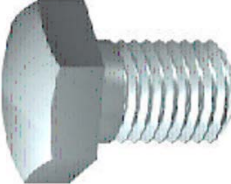

ČISTĚNÍ VÝMĚNÍKU	POZICE	POPIS	KÓD	ČÍSLO SOUČÁSTI	POČET KS	POZNÁMKY
	15	Těsné pero - A 5 x 5 x 22	MSRX0006	DIN 6885	1	
	16	Ploché podložky - 6 - 140 HV	MSPX0026	ISO 7089	1	
	17	Šestihranný šroub - M6 x 20	MSSX0006	ISO 4017	1	Zn
	18	Podložka 16	MSPX0030	DIN 125	2	

MECHANISMUS ČISTĚNÍ

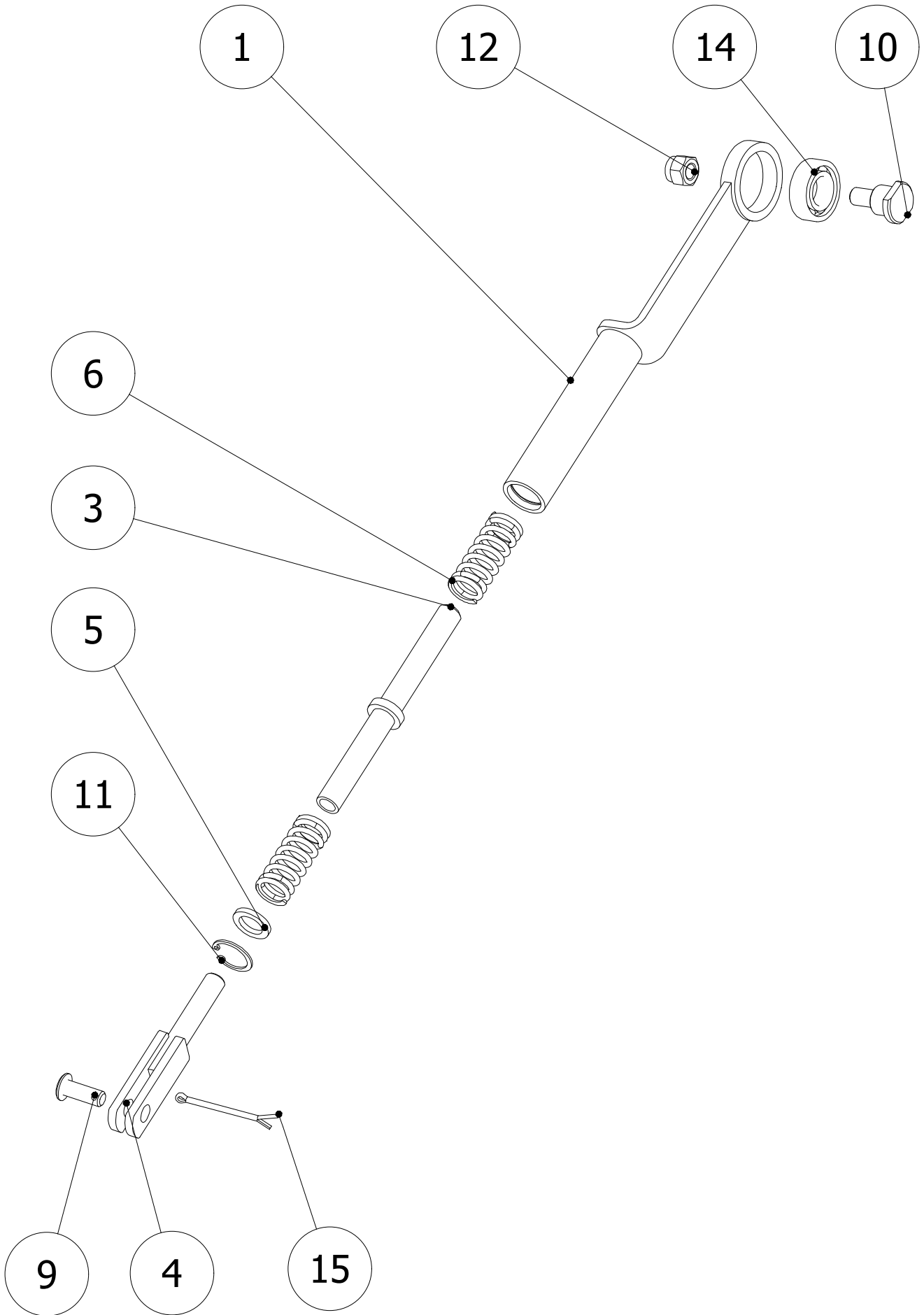

Mechanismus čišťení	POZICE	POPIS	KÓD	ČÍSLO SOUČÁSTI	POČET KS	POZNÁMKY
	1	ÓJE ČISTĚNÍ	PKTX0167	424.S01.000.A4	1	
	3	ČEP VEDENÍ	PKTX0170	424.003.000.A4	1	
	4	VIDLICE	PKTX0171	424.S04.000.A4	1	
	5	VÍČKO	MHVT0139	424.005.000.A4	1	
	6	PRUŽINA TLAČNÁ	MRUZ0065		2	
	9	ČEP 1	PKTX0175	424.009.000.A4	1	

Mechanismus čišění	POZICE	POPIS	KÓD	ČÍSLO SOUČÁSTI	POČET KS	POZNÁMKY
	10	ČEP	PKTX0176	424.010.000.A4	1	
	11	Pojistné kroužky pro díry - 22	MSRX0014	CSN 02 2931	1	
	12	Samojistné šestihřanné matice - M10	MSMX0006	ISO 7041	1	
	14	Kuličková ložiska jednořadá - 6003 2RS	MRUZ0048	CSN 02 4630	1	
	15	Závlačka - 3,2 x 50	MSRX0059	ISO 1234	1	

POHON ČISTĚNÍ

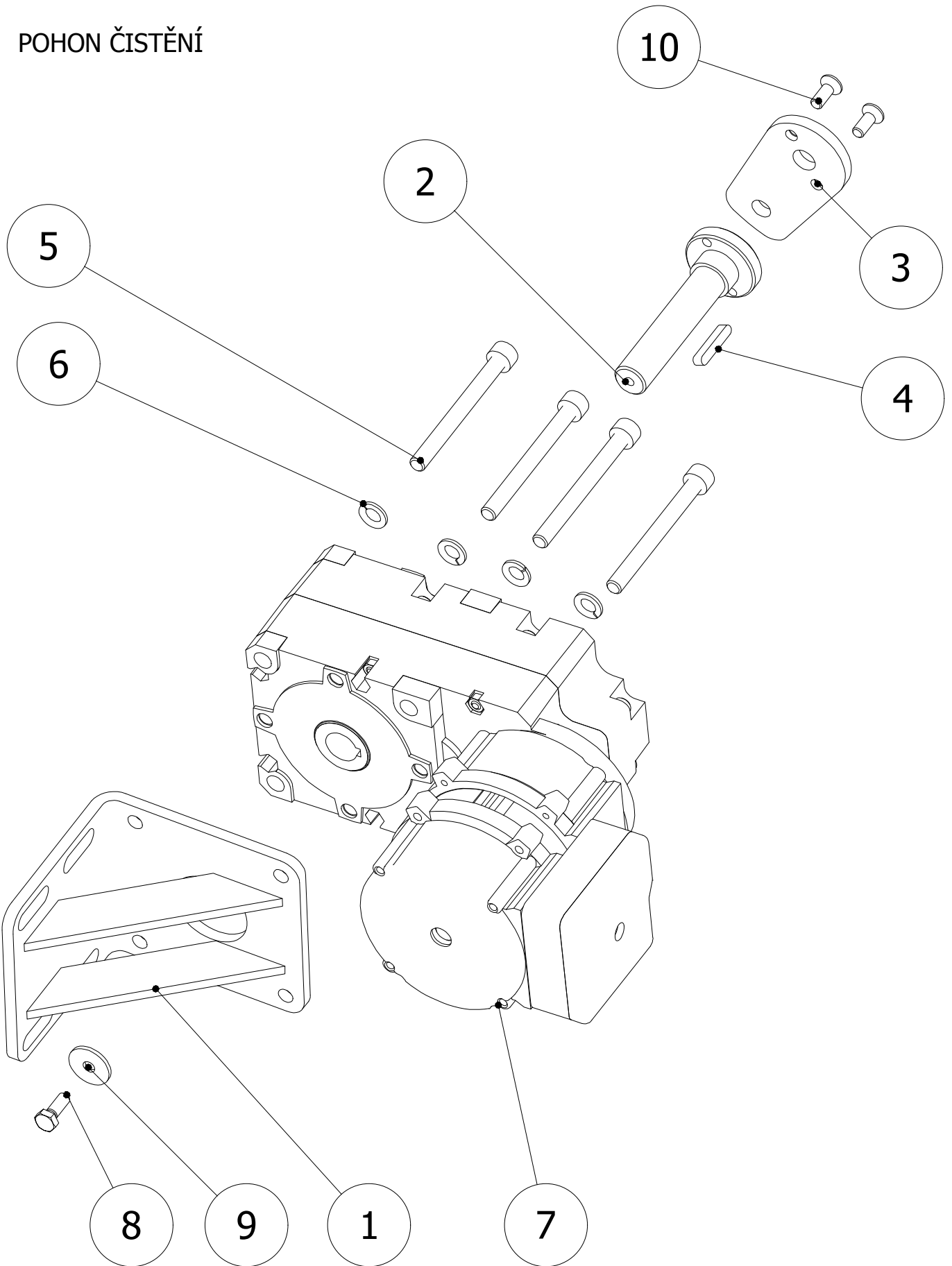

POHON ČISTĚNÍ TAHŮ	POZICE	POPIS	KÓD	ČÍSLO SOUČÁSTI	POČET KS	POZNÁMKY
	1	DRŽÁK MOTORU ABM	PKTX0216	446.S01.000.A3	1	
	2	UNAŠEČ	PKTX0218	446.002.000.A3	1	
	3	PÁKA	PKTX0179	397.S25.003.A4	1	
	4	Těsné pero - A 5 x 5 x 30	MSRX0007	DIN 6885	1	
	5	Šroub s válcovou hlavou - M8 x 80	MSSX0045	DIN 912	4	
	6	Pružná podložka - A8	MSPX0006	DIN 128	4	

POHON ČISTĚNÍ TAHŮ	POZICE	POPIS	KÓD	ČÍSLO SOUČÁSTI	POČET KS	POZNÁMKY
	7	Motor EPO MRB 0,12kW/2p	MEMP0037		1	
	8	Šestihranný šroub - M6 x 16	MSSX0015	DIN 933	1	
	9	Podložka 6	MSPX0002	DIN 440R	1	
	10	Šroub se zápustnou hlavou - M6 x 16	MSSX0096	DIN 7991	2	
	11	Kabel SIHF 3G 1	MEKV0003		1.5m	

# POHON VYMETÁNÍ POPELE

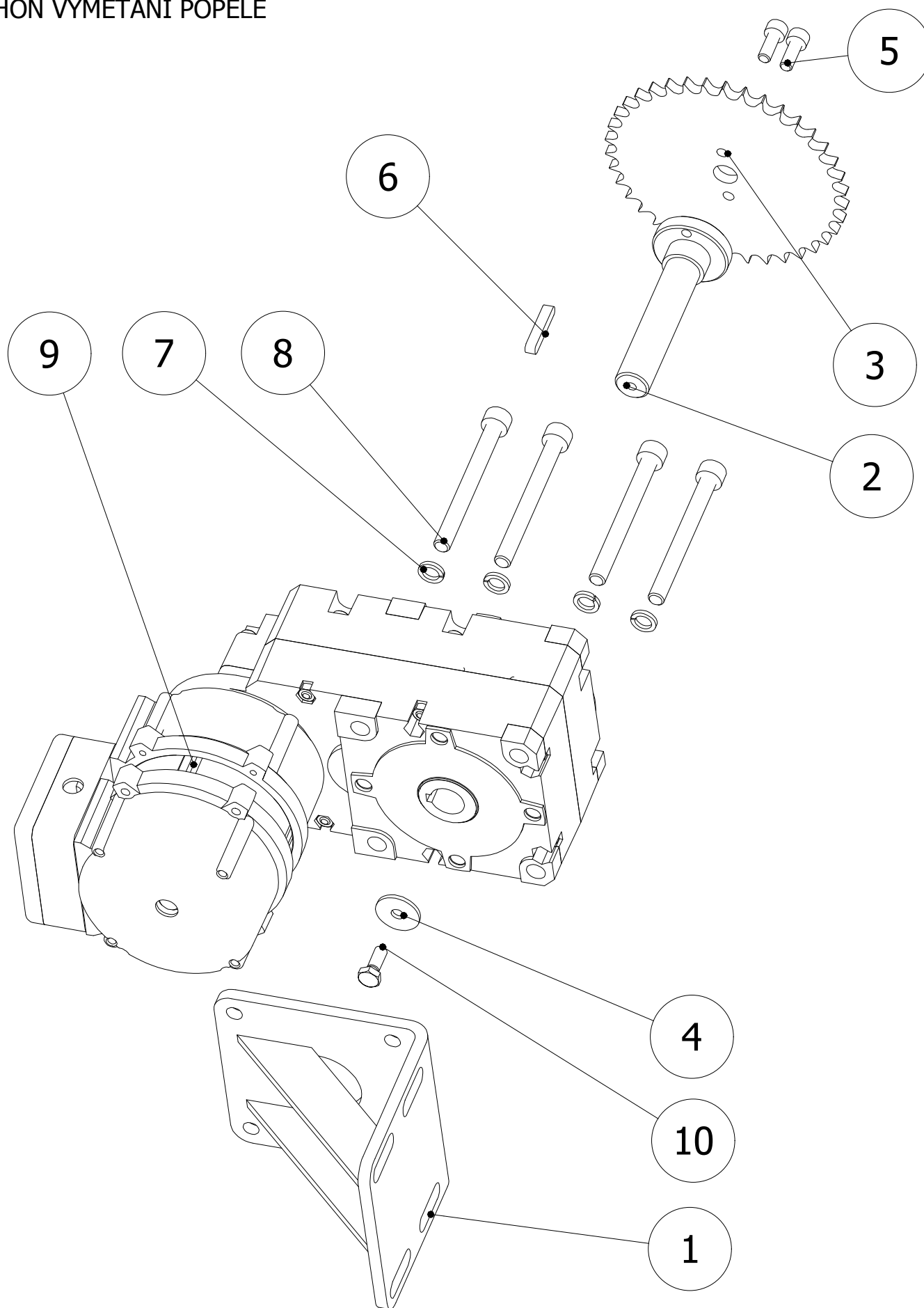



Pohon vymetání popela KP22	POZICE	POPIS	KÓD	ČÍSLO SOUČÁSTI	POČET KS	POZNÁMKY
	1	DRŽÁK MOTORU ABM	PKTX0216	446.S01.000.A3	1	
	2	UNAŠEČ	PKTX0218	446.002.000.A3	1	
	3	KOLO ŘETĚZOVÉ ÚPRAVA	PKTX0225	446.003.000.A4	1	
	4	Podložka 6	MSPX0002	DIN 440R	1	
	5	Šroub s válcovou hlavou - M6 x 16	MSSX0098	ISO 4762	2	
	6	Těsné pero - A 5 x 5 x 30	MSRX0007	DIN 6885	1	

Pohon vymetání popelé KP22	POZICE	POPIS	KÓD	ČÍSLO SOUČÁSTI	POČET KS	POZNÁMKY
	7	Pružná podložka - 8	MSPX0006	DIN 7980	4	
	8	Šroub s válcovou hlavou - M8 x 80	MSSX0045	DIN 912	4	
	9	Motor EPO MRB 0,06kW/4p	MEMPO03 5		1	
	10	Šestihrann ý šroub - M6 x 16	MSSX0015	DIN 933	1	
	11	ŘETĚZ 06 B-1, 103 ČLÁNKŮ (3.8x7.32)	MRUZ0141		1	
	12	ČLÁNEK SPOJOVACÍ JEDNOŘ.	MRUZ0041		1	
	13	KABEL SIHF 3G 1	MEKV0003		1.2m	

## ELEKTRO

KÓD	POPIS	MNOŽSTVÍ
MEKV0003	Kabel SIHF 3G 1	3,44 m
MEKV0037	Kabel H07V-K 1,5 zž	3,0 m
MEKV0047	Šňůra FLEX H05VV-F 3x1,5 5m	1,0 ks
MEKV0071	Kabel H07V-K 1,5 sv.modr	2,5 m
MEKV0072	Kabel H07V-K 1,5 černý	3,0 m
MERX0003	Objímka plochá BF-F 608P	3,0 ks
MERX0004	Dutinka lis. DI 1.0-10 10	20,0 ks
MERX0016	Svorka WAGO 222-413	4,0 ks
MERX0027	Trubička smršť. 3,2/1,6 SB/PBF-1/8	0,05 m
MERX0029	Dutinka lisov. DI 1,5-10	24,0 ks
MERX0030	Objímka plochá RF-F 608P	12,0 ks
MERX0051	Vývodka PG 9 s matkou	16,0 ks
MERX0067	Přichytka PKB-BS 27x27mm přírodní samolepící	3,0 ks
MERX0069	Dutinka lis. DI 0,5-10	4,0 ks
MERX0073	Svorka WAGO 222-415	1,0 ks
MERX0078	Štítek uzemění malý /baleno po 40 ks/	4,0 ks
MERX0151	Spirála svazkovací SPC10	1,0 m
MERX0158	Pásek vázací 200/3,6	8,0 ks
MERX0205	Vývodka PG 7	9,0 ks
MERX0212	Dutinka lis. DI 0,25-8-8	10,0 ks
MERX0221	Kolík ploch.přístroj. SEZC7202-00/4/100	5,0 ks
MERX0237	Konektor RJ 45-8/8 C5 dr vidlice	1,0 ks
MERX0282	Konektor RJ 45-8 Cat.5e UTP	1,0 ks
MERX0581	Filtr odrušovací MIFLEX FP-250/16	1,0 ks
MERX0631	Konektor 2,5 / 3 green SIGMATEK	16,0 ks
MERX0632	Konektor 1,5 / 2 green SIGMATEK	15,0 ks
MERX0633	Konektor 2,5 / 2 green SIGMATEK	1,0 ks
MERX0634	Konektor 2,5 / 4 green SIGMATEK	4,0 ks
MERX0635	Konektor 1,5 / 4 green SIGMATEK	1,0 ks
MERX0636	Konektor 1,5 / 3 green SIGMATEK	1,0 ks
MERX0646	Oko lisovací BF - M6	1,0 ks
MERX0648	Spirála svazkovací SPC15	0,5 m
MERX0661	Buž. smršť. SB 3,2/1,6 Mo modrá	0,06 m
MERX0662	Zástrčka ST18 -3 pol.č. Wieland	3,0 ks
METR0071	Deska základní HZS 521-G	1,0 ks
METR0072	Modul expandér HZS 532-1	1,0 ks
METR0083	Snímač teploty příložený KS 154A KTY 81-110, 3,5m	2,0 ks
METR0085	Snímač teploty TG8-55 KTY 81-110, 1,5m voda	1,0 ks
METR0087	Snímač teploty pro ven. KS 114B, KTY 81-110	1,0 ks
METR0108	Snímač teploty TR 050J-x TCK,silicon zelený 1,4m	1,0 ks
MREZ0012	Etiketa stříbrná 210x297 baleno po 20 ks	0,25 ks
MRUZ0211	FlaschDisk USB 2,0 Sandisk Cruzer Fit 8GB	1,0 ks
MRUZ0219	Průchodka 24,9 x 1,6 Moss 11214	1,0 ks
MRUZ0220	Podložka tlum. 10x10x2,5 čtvercová 35604-0	2,0 ks
MRUZ0272	Zátka antivibrační 1/2 BSP - velikost 8	1,0 ks
MRUZ0274	Zátka souběžná 46.1MM č.465668	2,0 ks
MRUZ0275	Fólie laminovací A4	1,0 ks

KÓD	POPIS	MNOŽSTVÍ
MTBX0033	Páska oboustranně lepící	0,02 ks



**PONAST spol. s r.o**  
Na Potůčkách 163  
757 01 Valašské Meziříčí

**ČESKÁ REPUBLIKA**

**[www.ponast.cz](http://www.ponast.cz)**

**tel.: 571 688 111\*, 800 700 068**

**e-mail: [servis@ponast.cz](mailto:servis@ponast.cz)**