



katalog náhradních dílů
automatického kotle
KP 62S



PONAST spol. s r.o
Na Potůčkách 163
757 01 Valašské Meziříčí
ČESKÁ REPUBLIKA
tel.: 571 688111*
e-mail: ponast@ponast.cz



aktualizace: 05/12/2018

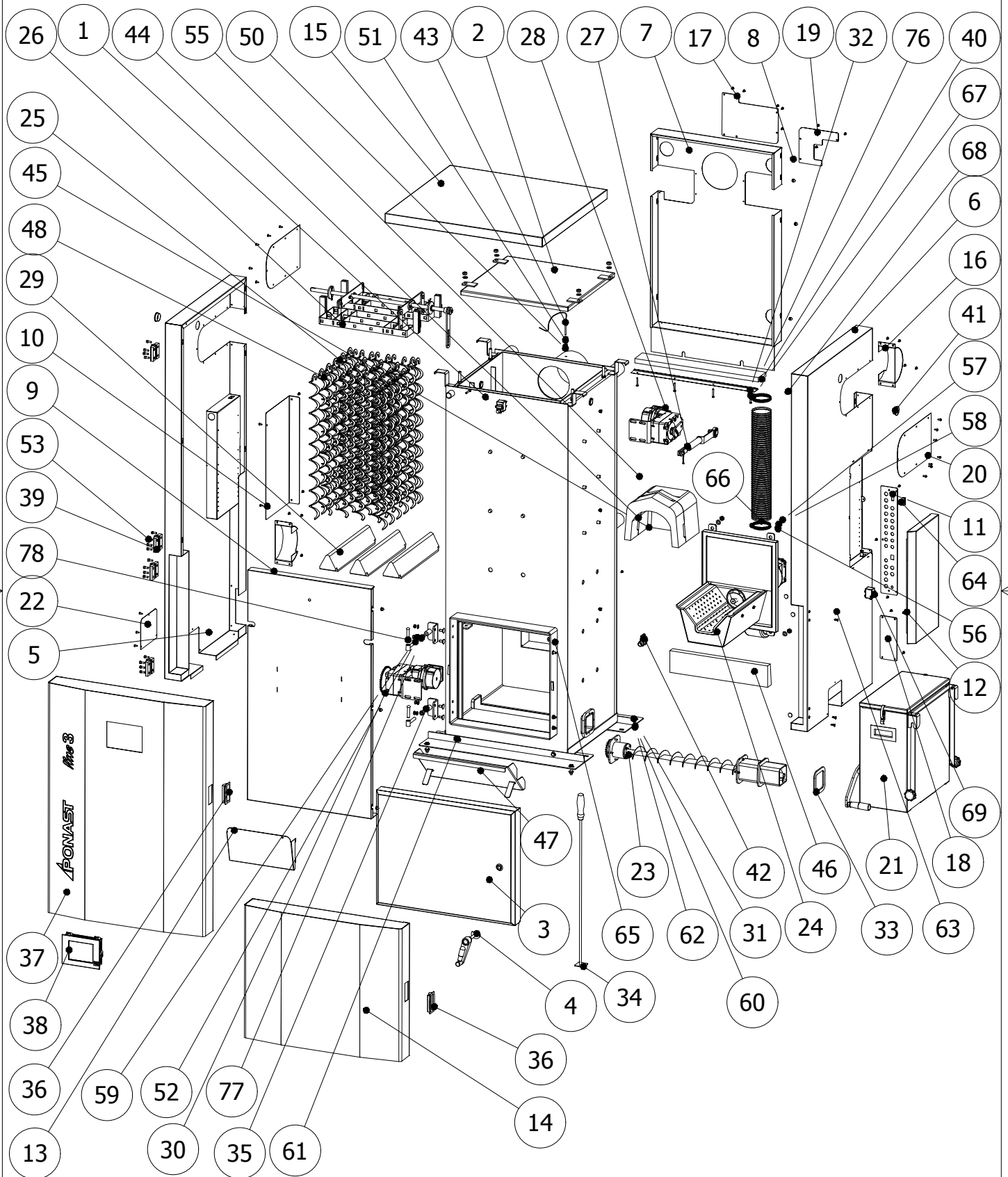

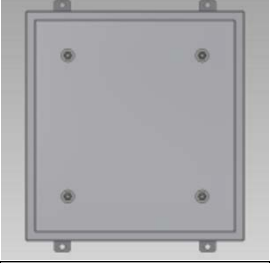
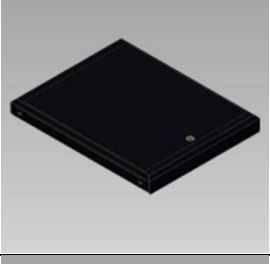

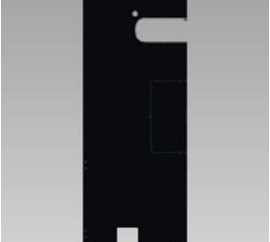

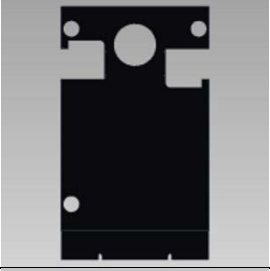
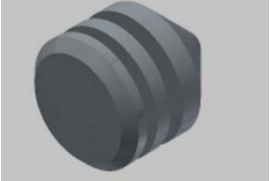
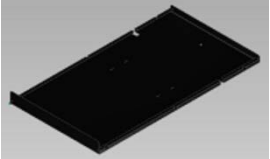
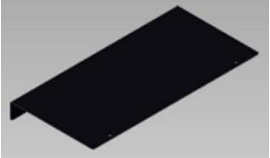

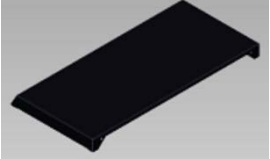

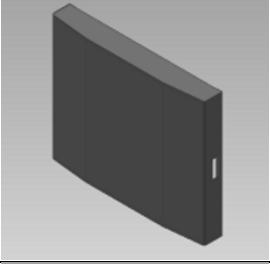
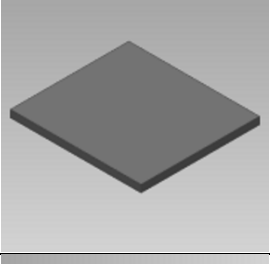
KOTEL KP62S









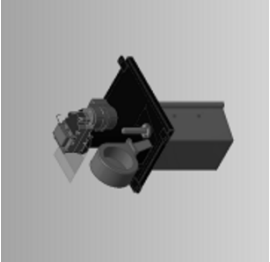

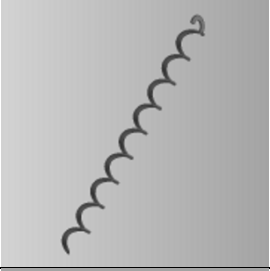
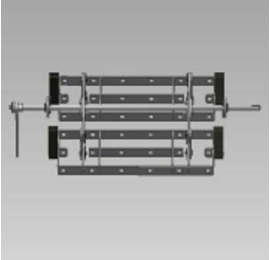
KOTEL KP62	POZICE	POPIS	KÓD	ČÍSLO SOUČÁSTI	POČET KS	POZNÁMKY
	1	TĚLESO KOTLOVÉ KP62	PKXX6201	338.S01.000.A1	1	Sestava
	2	VÍKO	KKTX0011	005.S02.000.A2	1	Sestava
	3	DVÍŘKA KP62	KKTX0034	338.S05.000.A3	1	Sestava
	4	KLIKA x2	KKTX0019	338.S04.000.A3	1	Sestava
	5	BOČNICE LEVÁ	PKMD0155	723.S01.000.A3	1	
	6	BOČNICE PRAVÁ	PKMD0157	723.S02.000.A3	1	

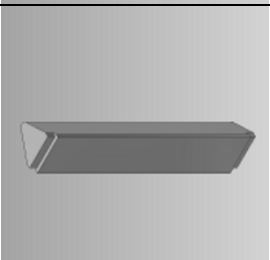
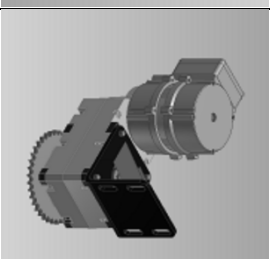
KOTEL KP62	POZICE	POPIS	KÓD	ČÍSLO SOUČÁSTI	POČET KS	POZNÁMKY
	7	KRYT ZADNÍ	PKMD0112	338.010.000.A2	1	
	8	KLÍČ	PKRX0008	286.000.000.A4	14	
	9	VZPĚRA 1	PKMD0166	723.006.000.A4	1	
	10	KRYT KRABICE	PKMD0168	723.008.000.A3	1	
	11	DESKA	PKMD0143	723.005.000.A4	1	
	12	KRYT JEDNOTKY BOČNÍ	PKMD0142	726.008.000.A3	1	

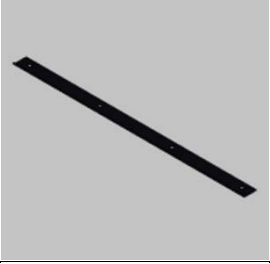

KOTEL KP62	POZICE	POPIS	KÓD	ČÍSLO SOUČÁSTI	POČET KS	POZNÁMKY
	13	ŠUPLÍK	PKMD0169	723.010.000.A3	1	
	14	KRYT DVEŘÍ KP62	PKMBB0162	723.S04.000.A3	1	
	15	VÍKO HORNÍ-SVAŘENEC	PKMBB0164	723.S05.000.A4	1	
	16	KRYT ČISTĚNÍ	PKMD0081	397.S13.000.A3	2	
	17	KRYTKA OTVORU MOTORU	PKMD0104	338.S06.002.A4	1	
	18	ZÁSLEPKA MOTORU	PKMD0099	338.S07.002.A4	1	

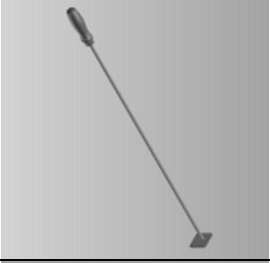
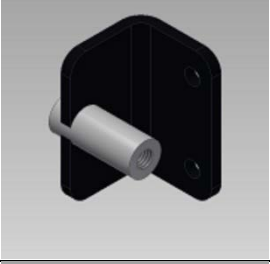
KOTEL KP62	POZICE	POPIS	KÓD	ČÍSLO SOUČÁSTI	POČET KS	POZNÁMKY
	19	KRYTKA ZAD	PKMD0102	338.S07.007.A4	1	
	20	KRYTKA POHONU ČISTĚNÍ	PKMD0071	397.S07.006.A3	2	
	21	POPELNICE 45L	KKTI0045 KKTI0027	568.000.000.A3	1	Sestava PRAVÁ LEVÁ
	22	KRYTKA POHONU VYMETÁNÍ 1	PKMD0105	338.S06.005.A3	1	
	23	VYMET.POPELE KP62	KKTX0035	334.000.000.A2	1	Sestava
	24	HOŘÁK 60KW EPO 2013	KHXX6012	613.V02.000.A3	1	Sestava

KOTEL KP62	POZICE	POPIS	KÓD	ČÍSLO SOUČÁSTI	POČET KS	POZNÁMKY
	25	TURBULÁTOR PLOCHÝ 645mm	MRUZ0027	005.014.000.A4	14	
	26	ČISTĚNÍ VÝMĚNÍKU KP52	KKTX0064	797.000.000.A3	1	Sestava
	27	MECHANISMUS ČISTĚNÍ	KKTX0024	424.000.000.A3	1	Sestava
	28	POHON ČISTĚNÍ TAHŮ	KKTX0041	727.S25.000.A3	1	Sestava
	29	KERAMIKA TROJÚHELNÍKOVÁ	MTKE0135	420.900.000.A3	3	
	30	POHON VYMETÁNÍ	KKTX0042	723.S24.000.A3	1	Sestava

KOTEL KP62	POZICE	POPIS	KÓD	ČÍSLO SOUČÁSTI	POČET KS	POZNÁMKY
	31	DRŽÁK KOTLE KP50,51	PKRX0046	356.000.000.A3	2	
	32	DRŽÁK SIBRALU	PKMD0120	338.056.000.A4	1	
	33	TĚSNĚNÍ	PKTX0157	334.S08.005.A4	1	
	34	ŠKRABKA	PKRX0001	001.S32.000.A4	1	
	35	PANT DÍL 2	PKTX0238	338.S01.S43.A3	2	
	36	Rukojeť EPR_90_Pf_C1	MRUZ0205		2	

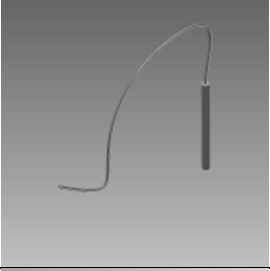
KOTEL KP62	POZICE	POPIS	KÓD	ČÍSLO SOUČÁSTI	POČET KS	POZNÁMKY
	37	ČELO KP62	PKMBB0159	723.S03.000.A3	1	
	38	TERMINÁL DOTYKOVÝ HZS 555-S	METR0073		1	
	39	Pant ELESA CFA.65-SL-H-V	PKTX0295		4	
	40	SIBREX 300 20x80x594	MTIZ0018		1	
	41	ZÁSLEPKA ČERNÁ 35-38mm	MRUZ0228		2	
	42	VENTIL VYPOŠTĚCÍ S PÁČKOU	MRUZ0024		1	

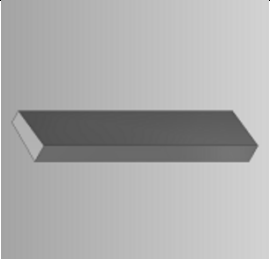
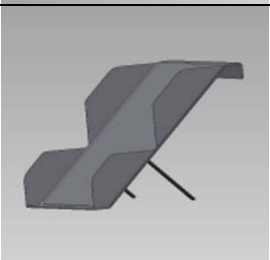
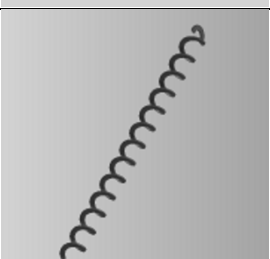
KOTEL KP62	POZICE	POPIS	KÓD	ČÍSLO SOUČÁSTI	POČET KS	POZNÁMKY
	43	Snímač teploty TR 050J-x TCK, 1,4m	METRO108		1	
	44	PODKOVA KP62	MTKE0014	333.100.000.A3	1	
	45	REFLEKTOR KP62	MTKE0013	332.100.000.A3	1	
	46	KERAMIKA NAD DV.KP50-62	MTKE0001	338.053.000.A4	1	
	47	LOPATKA KP62	PKTX0174	334.009.000.A3	1	
	48	TURBULÁTOR PLOCHÝ 645mm	MRUZ0223	749.014.000.A4	22	

KOTEL KP62	POZICE	POPIS	KÓD	ČÍSLO SOUČÁSTI	POČET KS	POZNÁMKY
	49	KRYT DVÍŘEK	PKMD0116	338.012.000.A2	1	
	50	REDUKCE DÍL 1	PKRX0062	792.001.000.A4	1	
	51	REDUKCE DÍL 2	PKRX0063	792.002.000.A4	1	
	52	PANT DVÍŘEK	PKTX0037	005.S05.S03.A4	2	
	53	Šroub s válcovou hlavou - M6 x 16	MSSX0224	DIN 912	16	
	55	Šrouby samořezné - ST 4,8 x 13	MSSX0118	ISO 7049	47	

KOTEL KP62	POZICE	POPIS	KÓD	ČÍSLO SOUČÁSTI	POČET KS	POZNÁMKY
	56	Vějířová pojistná podložka - A 10,5	MSPX0003	DIN 6798	2	
	57	Šestihranná matice - M10	MSMX0002	DIN 934	10	
	58	Podložka - A 10,5	MSPX0005	DIN 125	20	
	59	Podložka - A 8,4	MSPX0001	DIN 125	24	
	60	Šestihranná matice - M8	MSMX0016	DIN 934	26	
	61	Šestihranný šroub - M8 x 20	MSSX0002	DIN 933	4	

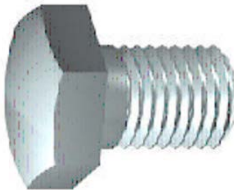
KOTEL KP62	POZICE	POPIS	KÓD	ČÍSLO SOUČÁSTI	POČET KS	POZNÁMKY
	62	Šestihranný šroub - M8 x 40	MSSX0027	DIN 933	4	
	63	Nýt zarážecí pr.5mm 27024050	MSSX0125		4	
	64	Vypínač SSk 315 RED	MERX0579		1	
	65	Šroub s půlk. hl.a 4hr.kr. - M8 x 20	MSSX0207	DIN 603	8	
	66	HADICE FLEXADUR PU- 1NO DN 80x1000	MRUZ0018		1	
	67	SPONA HADICOVÁ 70-90 NEREZ	MRUZ0089		2	

KOTEL KP62	POZICE	POPIS	KÓD	ČÍSLO SOUČÁSTI	POČET KS	POZNÁMKY
	68	MAGNET 18x2	MRUZ0077		4	
	69	HAVARIJNÍ TERMOSTAT LY 26 I	METR0049		2	
	76	Šroub do plechu - ST4,8 x 38	MSSX0042	ISO 7049	4	
	77	Šestihránné matice - M12	MSMX0007	ISO 4032	2	
	78	NÝT 10x50 Fe	MSRX0032	DIN 660	2	

TĚLESO KOTLOVÉ KP62

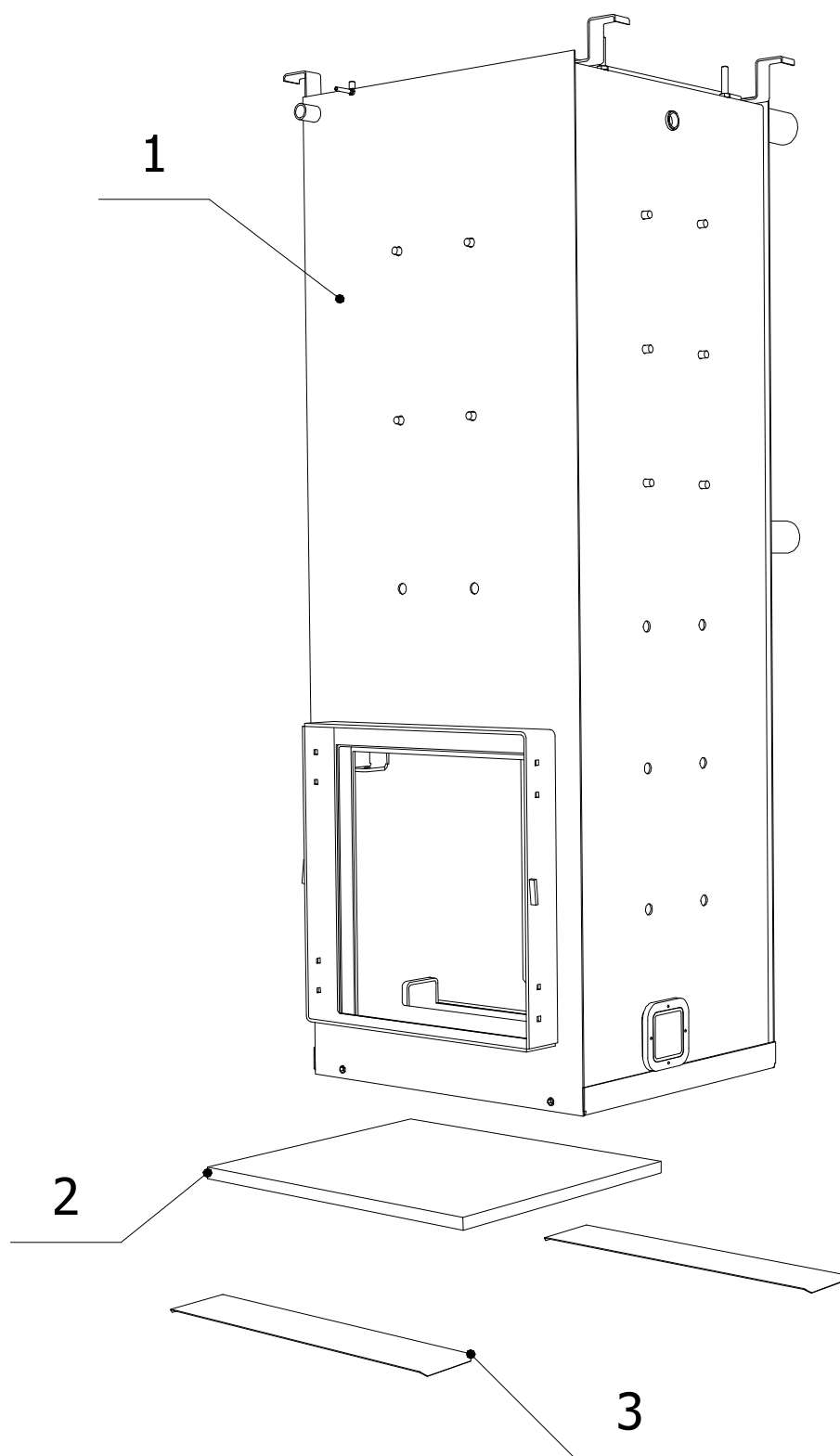

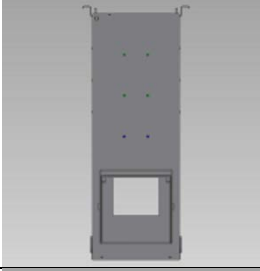
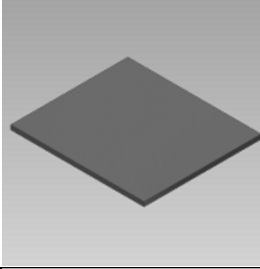
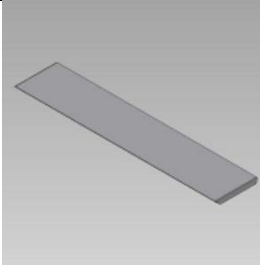
TĚLESO KOTLOVÉ KP62	POZICE	POPIS	KÓD	ČÍSLO SOUČÁSTI	POČET KS	POZNÁMKY
	1	TĚLESO KOTLOVÉ KP62	PKXX6201	338.S01.000.A1	1	
	2	IZOLACE 20x515x586	PKTX0344		1	
	3	DRŽÁK IZOLACE KP51,KP82	KKTXX0348		2	

VÍKO

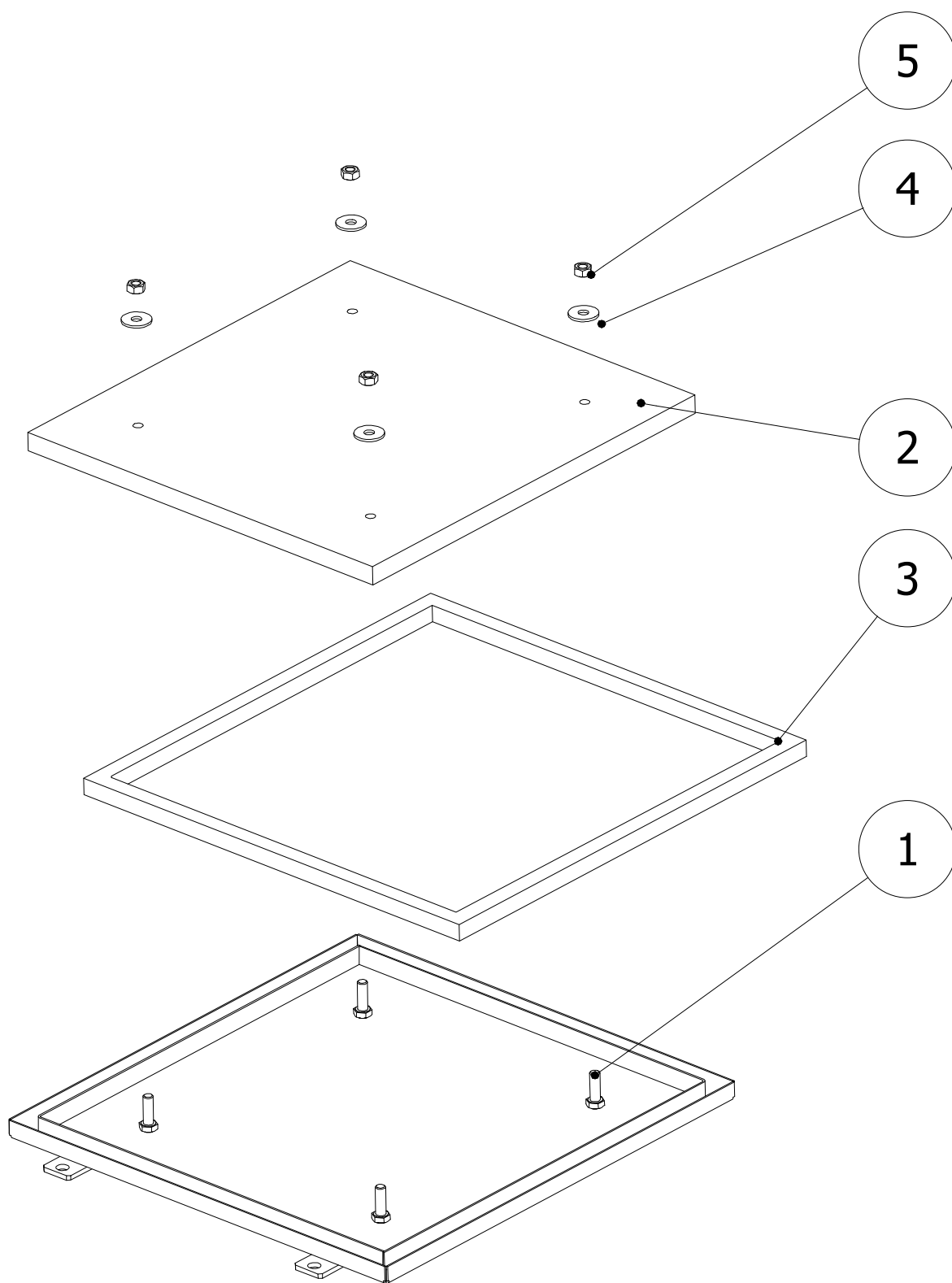

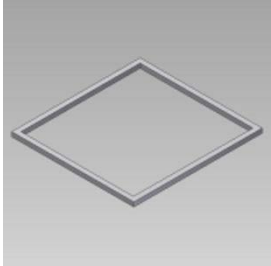

VÍKO	POZICE	POPIS	KÓD	ČÍSLO SOUČÁSTI	POČET KS	POZNÁMKY
	1	VÍKO KOTL.TĚLESA KP50,51	PKTX0100	005.002.000.A2	1	
	2	SIBREX 140 20x446x475	MTIZ0001		1	
	3	ŠŇŮRA VÍKA 18x18	MRUZ0133		1.52m	
	4	Podložka - 10,5	MSPX0004	DIN 9021	4	
	5	Šestihranné matice - M10	MSMX0002	ISO 4032	4	

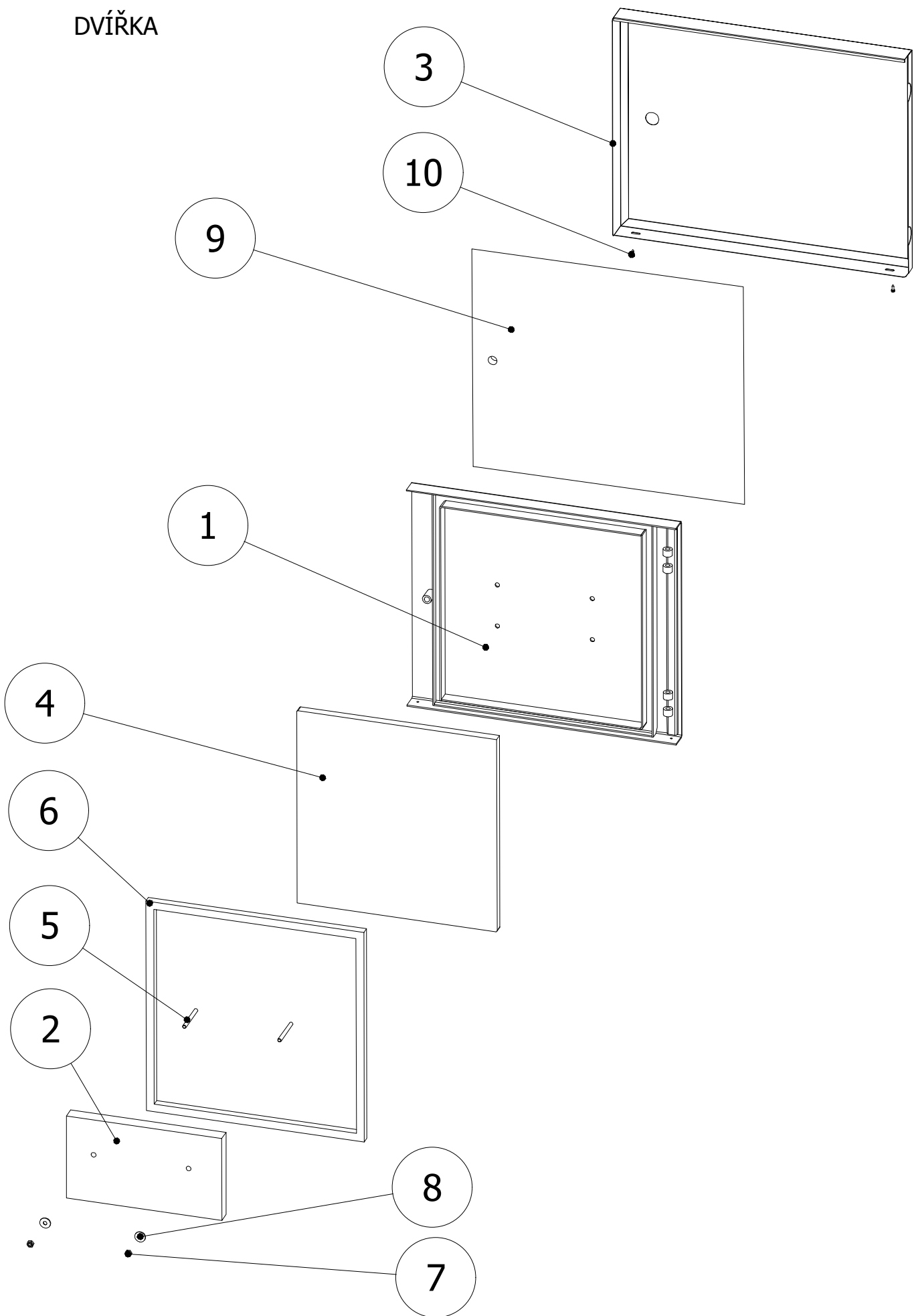
DVÍŘKA

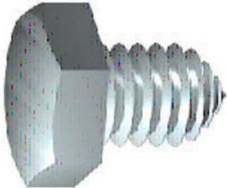

DVÍŘKA	POZICE	POPIS	KÓD	ČÍSLO SOUČÁSTI	POZICE KS	POZNÁMKY
	1	DVÍŘKA	PKTX0243	338.005.000.A3	1	
	2	KERAMIKA NA DVÍŘKA KP62	MTKE0010	338.017.000.A4	1	
	3	KRYT DVÍŘEK	PKMD0116	338.012.000.A2	1	
	4	SIBREX 300 20x457.5x467	MTIZ0008		1	
	5	TYČ ZÁVITOVÁ M8x85	PKTX0268		2	
	6	ŠŇŮRA TĚSN. 18x18	MRUZ0133		2.01m	

DVÍŘKA	POZICE	POPIS	KÓD	ČÍSLO SOUČÁSTI	POZICE KS	POZNÁMKY
	7	Šestihránná matice - M8	MSMX0016	DIN 934	2	Zn
	8	Podložka - 8,4	MSPX0008	DIN 9021	2	
	9	IZOLACE DVÍŘEK KP62 20x530x620	MTIZ0011		1	
	10	Šroub do plechu - ST4,2 x 13	MSSX0012	ISO 1479	2	

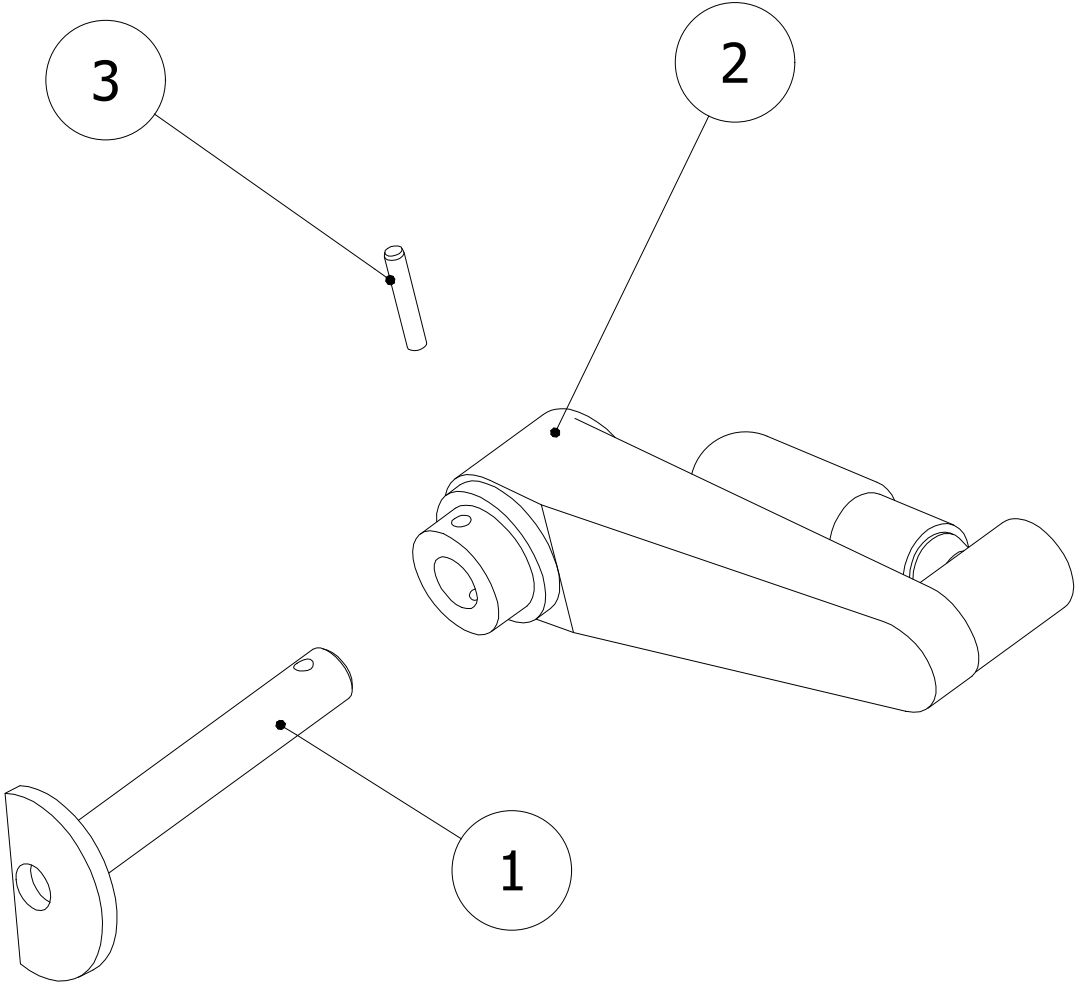

KLIKA

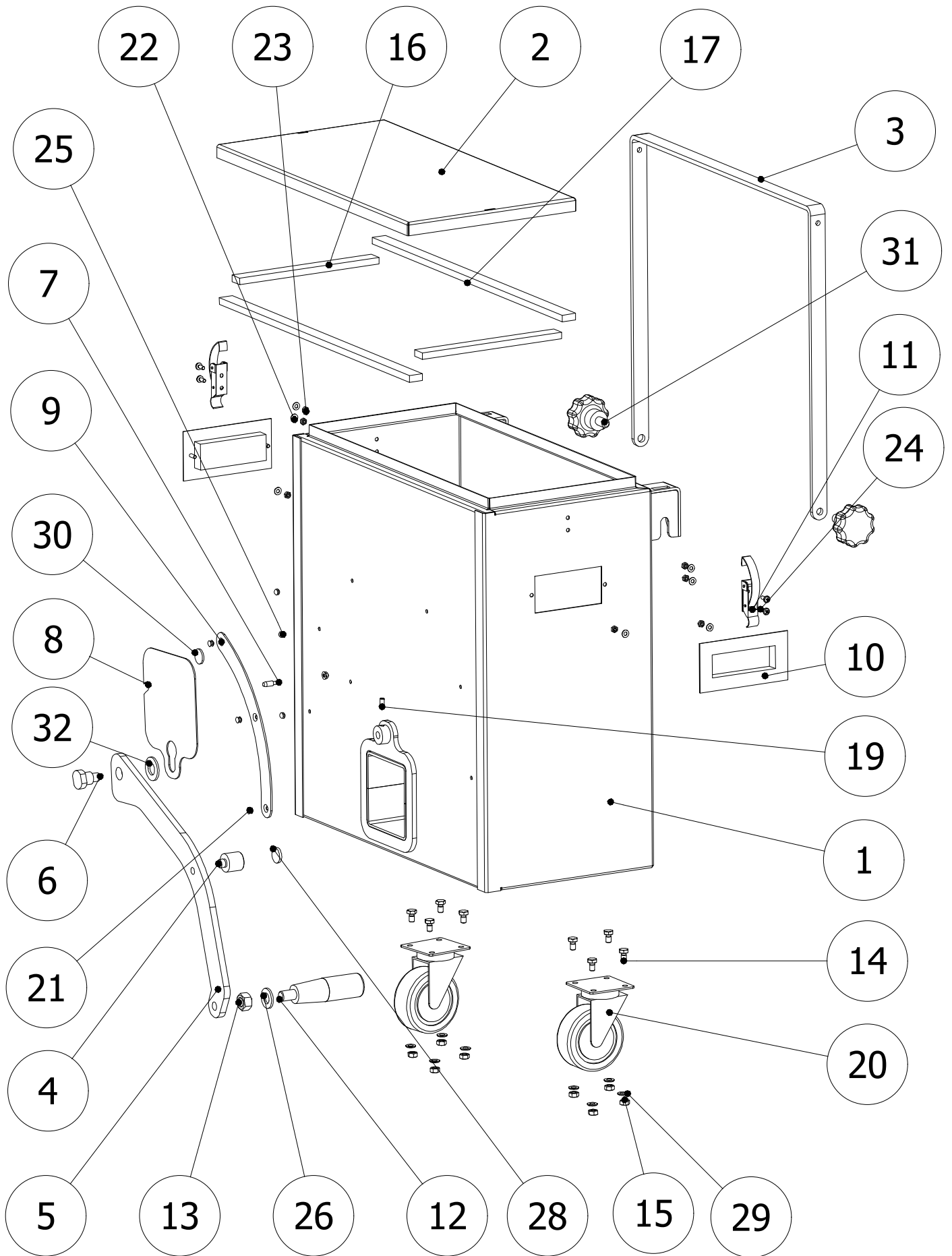

KLIIKA	POZICE	POPIS	KÓD	ČÍSLO SOUČÁSTI	POČET KS	POZNÁMKY
	1	DŘÍK KLIKY	PKTX0118	054.S04.001.A3	1	
	2	KLIIKA SKLAPOVACÍ ELESA GANTER	MRUZ0117	MT.100-AT+IR	1	KÓD 44317
	3	Kolík - 4 x 24 - A (kalený)	MSRX0003	ISO 8734	1	

POPELNICE 45L

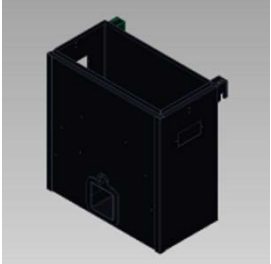
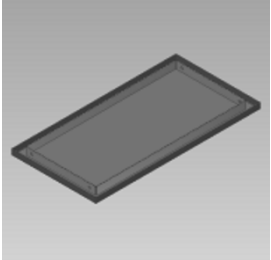
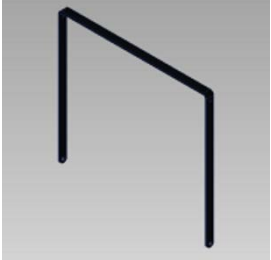
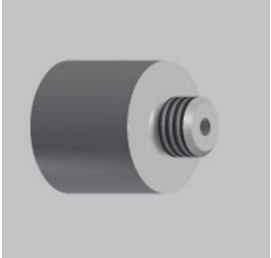

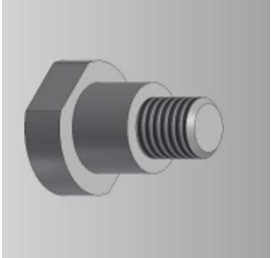



POPELNICE 45L	POZICE	POPIS	KÓD	ČÍSLO SOUČÁSTI	POČET KS	POZNÁMKY
	1	POPELNICE 45L OBAL	PKTD0182	568.S01.000.A3	1	
	2	DEKL POPELNICE 45L	PKTBB0193	568.S03.000.A4	1	
	3	DRŽADLO	PKTD0199	448.011.000.A4	1	
	4	DRŽÁK MAGNETICKÝ	PKTX0198	448.009.000.A4	1	
	5	PÁKA	PKTD0196	448.005.000.A3	1	
	6	ŠROUB	PKTX0197	448.006.000.A4	1	

POPELNICE 45L	POZICE	POPIS	KÓD	ČÍSLO SOUČÁSTI	POČET KS	POZNÁMKY
	7	DISTANCE	PKMX0037	054.009.003.A4	1	
	8	ZÁKLOPKA	MHVT0186	448.012.000.A4	1	
	9	DRÁHA	PKTX0201	448.028.000.A4	1	
	10	ÚCHYTKA ZAPUŠTĚNÁ UWAUNS	MRUZ0200	ÚCHYT	2	
	11	UZÁVĚR UP3	MRUZ0010		2	
	12	DLOUHÁ KUŽ. RUKOJEŤ	MRUZ0062	OBJ.Č.460650	1	

POPELNICE 45L	POZICE	POPIS	KÓD	ČÍSLO SOUČÁSTI	POČET KS	POZNÁMKY
	13	Šestihranné matice - M12	MSMX0007	ISO 4032	1	
	14	Šestihranný šroub - M6 x 10	MSSX0019	DIN 933	8	Zn
	15	Šestihranné matice - M6	MSMX0001	ISO 4032	8	
	16	TĚSNĚNÍ SILIKONOVÉ 8x18-190	MRUZ0090		2	
	17	TĚSNĚNÍ SILIKONOVÉ 8x18-443	MRUZ0122		2	
	19	Šroub stavěcí M5x10	MSRX0015	ISO 7434	1	

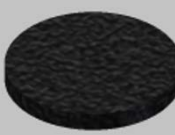
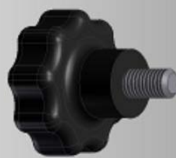
POPELNICE 45L	POZICE	POPIS	KÓD	ČÍSLO SOUČÁSTI	POČET KS	POZNÁMKY
	20	KOLO PEVNÉ EGA 075/FLP PR.75	MRUZ0056	FA.MONTAKO	2	
	21	Nýt se záp.hl. 4x8 Al	MSRX0013		3	
	22	Ploché podložky - 4	MSPX0014	ISO 7089	9	
	23	Šestihránné matice - M4	MSSX0012	ISO 4032	9	
	24	Šrouby s válč. hl. s kří. drážk. - M4 x 10	MSSX0010	ISO 7045	4	
	25	Nýt trhací 4 x 8 Al	MSRX0013	DIN 660 - A	3	

POPELNICE 45L	POZICE	POPIS	KÓD	ČÍSLO SOUČÁSTI	POČET KS	POZNÁMKY
	26	Ploché podložky - 12	MSPX0020	ISO 7089	1	
	28	MAGNET 18x3	MRUZ0088		1	
	29	Ploché podložky - 6	MSPX0026	ISO 7090	8	
	30	MAGNET 18x2	MRUZ0077		1	
	31	ŠROUB KOVOVÝ S PLAST.HLAVOU M10x17	MRUZ0032	OBJ.Č.105a-068-D/MxL	2	
	32	Podložka - A 16	MSPX0022	DIN 125	1	

VYMETÁNÍ POPELE

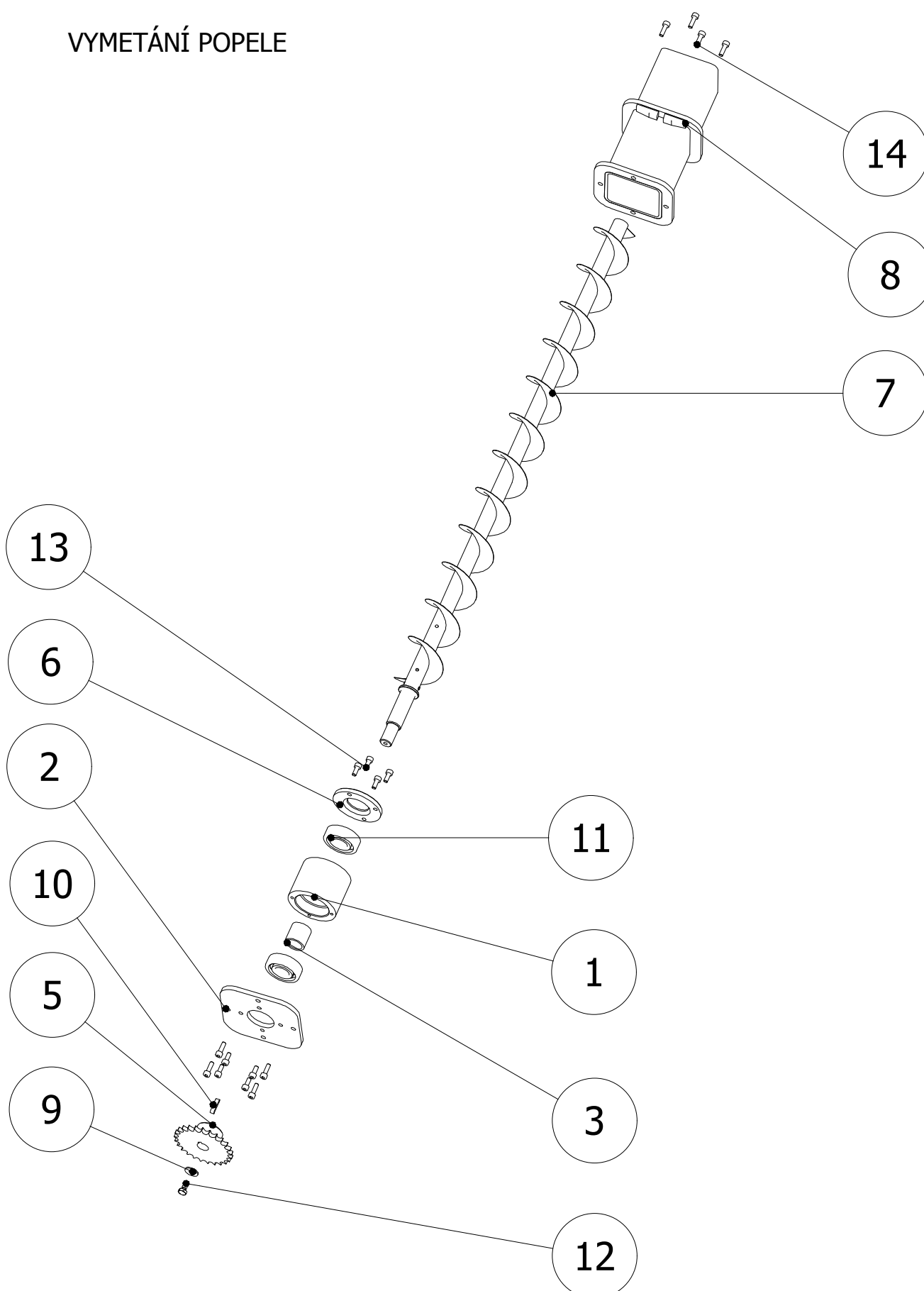

VYMETÁNÍ POPELE	POZICE	POPIS	KÓD	ČÍSLO SOUČÁSTI	POČET KS	POZNÁMKY
	1	NÁBOJ	PKTX0140	334.001.000.A4	1	
	2	VÍKO 1	PKTX0150	334.002.000.A4	1	
	3	DISTANCE	PKTX0440	334.003.000.A4	1	
	5	KOLO ŘETĚZOVÉ S NÁB.3/8"x7/32 "	PKTX0143	334.005.000.A4	1	
	6	VÍKO 2	PKTX0144	334.006.000.A4	1	
	7	ŠNEK	PKTX0146	334.S07.000.A3	1	

VYMETÁNÍ POPELE	POZICE	POPIS	KÓD	ČÍSLO SOUČÁSTI	POČET KS	POZNÁMKY
	8	VEDENÍ ŠNEKU	PKTX0153	334.S08.000.A3	1	
	9	Podložka - 6,4	MSPX0002	DIN 9021	1	
	10	Těsné pero - A 5 x 5 x 22	MSRX0006	DIN 6885	1	
	11	Kuličková ložiska jednořadá - 6204	MRUZ024 6	CSN 02 4630	2	
	12	Šestihranný šroub - M6 x 10	MSSX0019	DIN 933	1	Zn
	13	Šroub s válcovou hlavou - M5 x 12	MSSX0137	DIN 912	8	

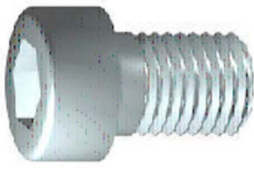

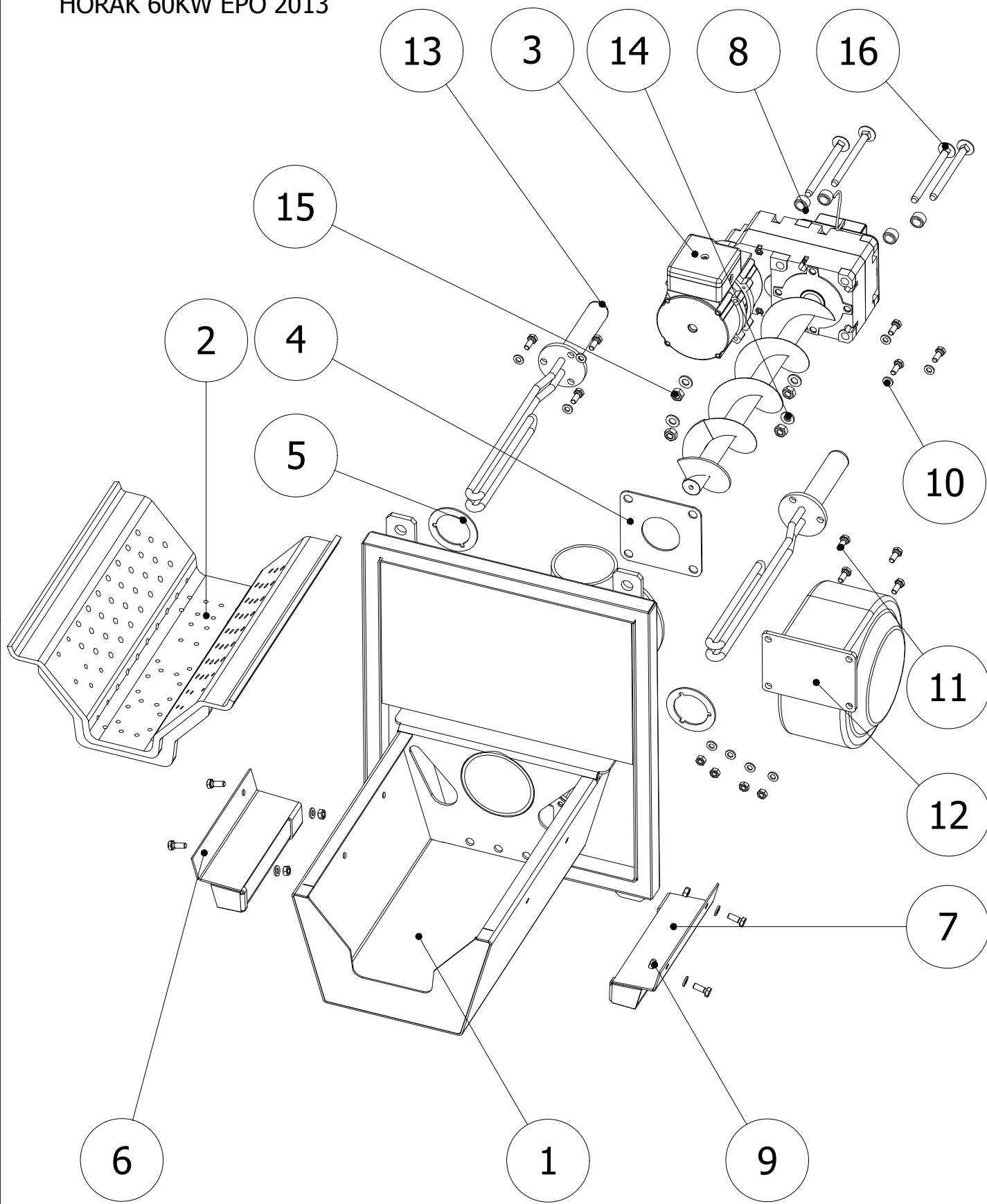

VYMETÁNÍ POPELE	POZICE	POPIS	KÓD	ČÍSLO SOUČÁSTI	POČET KS	POZNÁMKY
	14	Šroub s válcovou hlavou - M5 x 16	MSSX0055	DIN 912	8	

HOŘÁK 60KW EPO 2013

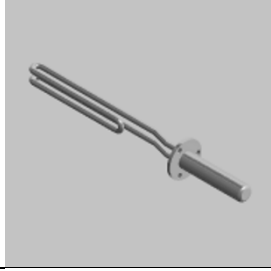

HOŘÁK 60KW EPO 2013	POZICE	POPIS	KÓD	ČÍSLO SOUČÁSTI	POČET KS	POZNÁMKY
	1	HOŘÁK 60KW UNIVERZÁLNÍ SVAŘENEC+TĚSNĚ NÍ+SIBREX	KHXX6004	613.001.000.A3	1	Sestava
	2	DESKA HOŘÁKOVÁ 60KW- OCELOLITINA	MHRX0037	613.002.000.A3	1	
	3	PODAVAČ P2 UNIVERSAL EPO 2013 SIGM.	KHXX6013	613.S04.000.A3	1	Sestava
	4	MEZIKUS PRO EPOMOTORY 2013	PHXX0161	428.300.000.A4	1	
	5	TĚSNĚNÍ	PHXX0115	493.021.000.A4	2	
	6	TUNEL LEVÝ	PHXX0108	613.014.000.A3	1	

HOŘÁK 60KW EPO 2013	POZICE	POPIS	KÓD	ČÍSLO SOUČÁSTI	POČET KS	POZNÁMKY
	7	TUNEL PRAVÝ	PHXX0107	613.015.000.A3	1	
	8	DISTANCE DRŽÁKU SNÍMAČE	PHXX0162	428.400.000.A4	4	
	9	Šestihhrané matice - M6	MSMX0001	ISO 4032	8	
	10	Ploché podložky - 6	MSPX0026	ISO 7089	14	
	11	Šestihhraný šroub - M6 x 16	MSSX0015	DIN 933	14	
	12	VENTILÁTOR RG12S-2EP	MEVE0017		1	

HOŘÁK 60KW EPO 2013	POZICE	POPIS	KÓD	ČÍSLO SOUČÁSTI	POČET KS	POZNÁMKY
	13	SPIRÁLA ZAPALOVACÍ 1000W	MERX0139		2	
	14	Ploché podložky - 8	MSPX0001	ISO 7089	4	
	15	Šestihranné matice - M8	MSMX0016	ISO 4032	4	
	16	Šroub s půlk.hl.a 4rh.krčkem - M8 x 100	MSSX0129	DIN 603	4	

HOŘÁK 60KW UNIVERZÁLNÍ SVAŘENEC+TĚSNĚNÍ+SIBREX

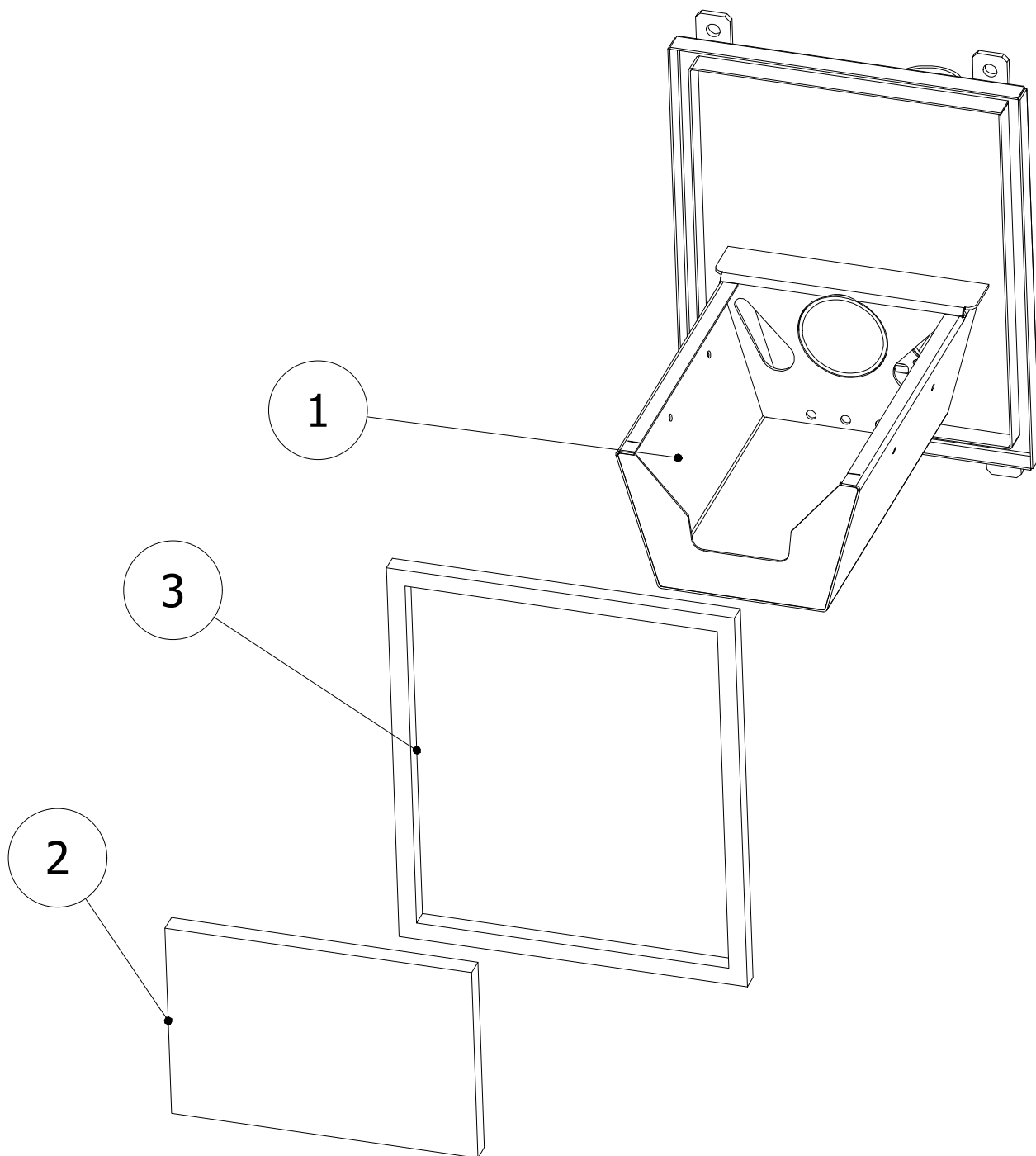

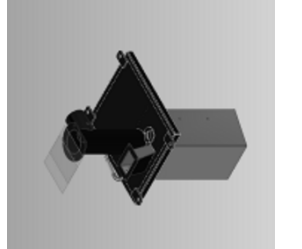
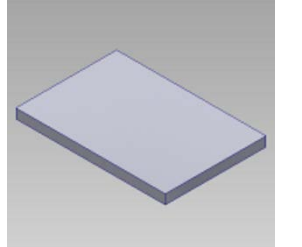
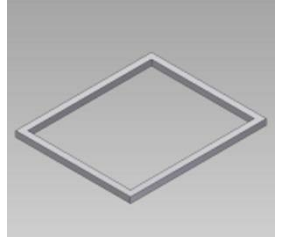

HOŘÁK 60KW UNIVERZÁLNÍ SVAŘENEC+TĚSNĚNÍ+ SIBREX	POZICE	POPIS	MATERIÁL	ČÍSLO SOUČÁSTI	POČET KS	POZNÁMKY
	1	HOŘÁK 60KW UNIVERZÁLNÍ - SVAŘENEC		613.S00.000.A3	1	
	2	DESKA 20x209x310	S235JRG2	DESKA 20x209x310	1	
	3	ŠŇŮRA TĚSNÍCÍ 18x18	S235JRG2	ŠŇŮRA TĚSNÍCÍ 18x18-1536 DS 000	1.54m	

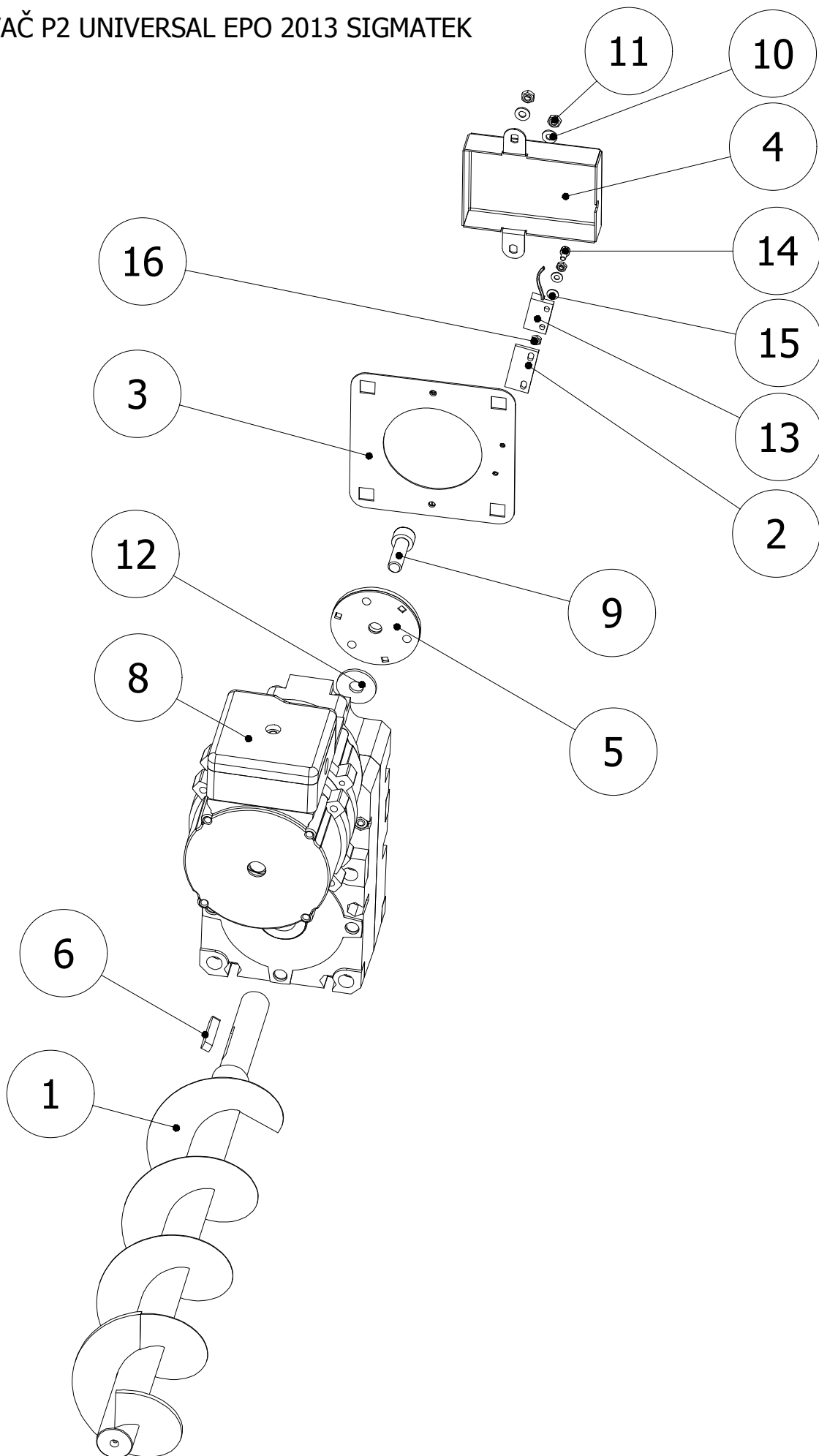
PODAVAČ P2 UNIVERSAL EPO 2013 SIGMATEK

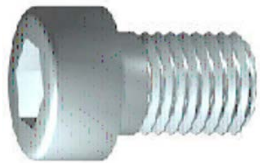

PODAVAČ P2 UNIVERSAL EPO 2013 SIGM.	POZICE	POPIS	KÓD	ČÍSLO SOUČÁSTI	POČET KS	POZNÁMKY
	1	ŠNEK KP62 PRO MOTOR ABM	PHXX0069	376.S15.000.A3	1	Délka 448mm
	2	Adaptér pro MK04	PHXX0214	798.110.001.A4	1	
	3	DRŽÁK SNÍMAČE OTÁČEK	MHVH0119	428.100.000.A4	1	
	4	KRABÍČKA SNÍMAČE SIGMATEK	MHVH0115	786.000.000.A4	1	
	5	KOLO SNÍMAČE MEDER MK04/EPO	PHXX0213	PHXX0213	1	
	6	Těsné pero - A 5 x 5 x 30	MSRX0007	DIN 6885	1	

PODAVAČ P2 UNIVERSAL EPO 2013 SIGM.	POZICE	POPIS	KÓD	ČÍSLO SOUČÁSTI	POČET KS	POZNÁMKY
	8	Motor EPO MRB 0,06kW/4p	MEMP0035		1	
	9	Šroub s válcovou hlavou - M8 x 25	MSSX0095	DIN 912	1	
	10	Ploché podložky - 4	MSPX0014	ISO 7089	2	
	11	Šestihranné matice - M4	MSSX0012	ISO 4032	2	
	12	Podložka - 8,4	MSPX0008	DIN 9021	1	
	13	Snímač MEDER MK04- 1A66-dl. 1900mm	MERX0777		1	

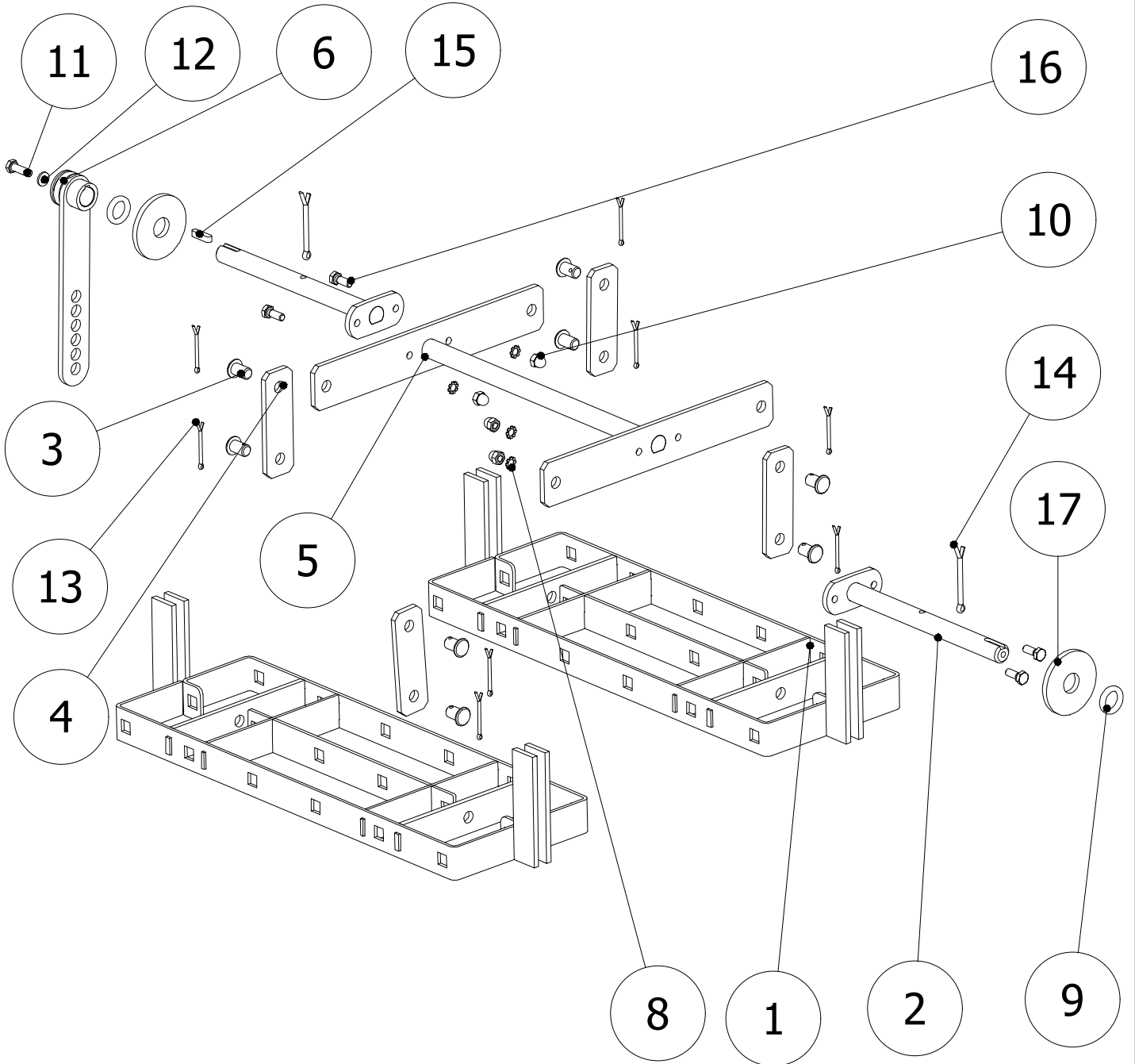

PODAVAČ P2 UNIVERSAL EPO 2013 SIGM.	POZICE	POPIS	KÓD	ČÍSLO SOUČÁSTI	POČET KS	POZNÁMKY
	14	Šroub s válcovou hlavou - M3 x 6	MSSX0226	DIN 912	1	
	15	Ploché podložky - 3	MSPX0031	ISO 7089	2	
	16	Šestihranné matice - M3	MSMX0024	ISO 4032	2	

ČISTĚNÍ VÝMĚNÍKU

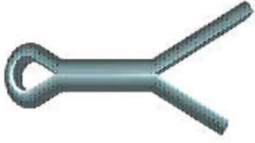
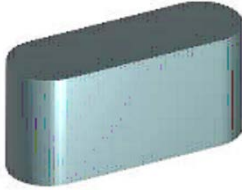
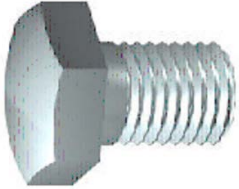

ČISTĚNÍ VÝMĚNÍKU	POZICE	POPIS	KÓD	ČÍSLO SOUČÁSTI	POČET KS	POZNÁMKY
	1	VAHADLO	PKTX0391	797.S01.000.A3	2	
	2	NÁSTAVEC	PKTX0389	797.S06.S00.A4	2	
	3	ČEP	PKTX0053	005.S16.007.A4	8	
	4	ZÁVĚS	PKTX0051	005.S16.004.A4	4	
	5	HŘÍDEL SPOJOVACÍ	PKTX0291	761.S06.A00.A3	1	
	6	RAMENO	PKTX0163	445.S08.000.A4	1	

ČISTĚNÍ VÝMĚNÍKU	POZICE	POPIS	KÓD	ČÍSLO SOUČÁSTI	POČET KS	POZNÁMKY
	8	Vějířová pojistná podložka- A 6,4	MSPX0012	DIN 6797	4	
	9	Šňůra těs. čišťení 4x4	PKTX0432		2	
	10	Šestihranná matice uzavřená - M6	MSMX0027	DIN 1587	4	
	11	Šestihranný šroub - M6 x 20	MSSX0006	ISO 4017	1	Zn
	12	Ploché podložky - 6 - 140 HV	MSPX0026	ISO 7089	1	
	13	Závlačka - 2,5 x 36	MSRX0048	ISO 1234	8	

ČISTĚNÍ VÝMĚNÍKU	POZICE	POPIS	KÓD	ČÍSLO SOUČÁSTI	POČET KS	POZNÁMKY
	14	Závlačka - 4 x 50	MSRX0021	ISO 1234	2	
	15	Těsné pero - A 5 x 5 x 22	MSRX0006	DIN 6885	1	
	16	Šestihranný šroub - M6 x 16	MSSX0015	DIN 933	4	
	17	Ploché podložky - ST 16 - 100 HV	MSPX0030	ISO 7094	2	

MECHANISMUS ČISTĚNÍ

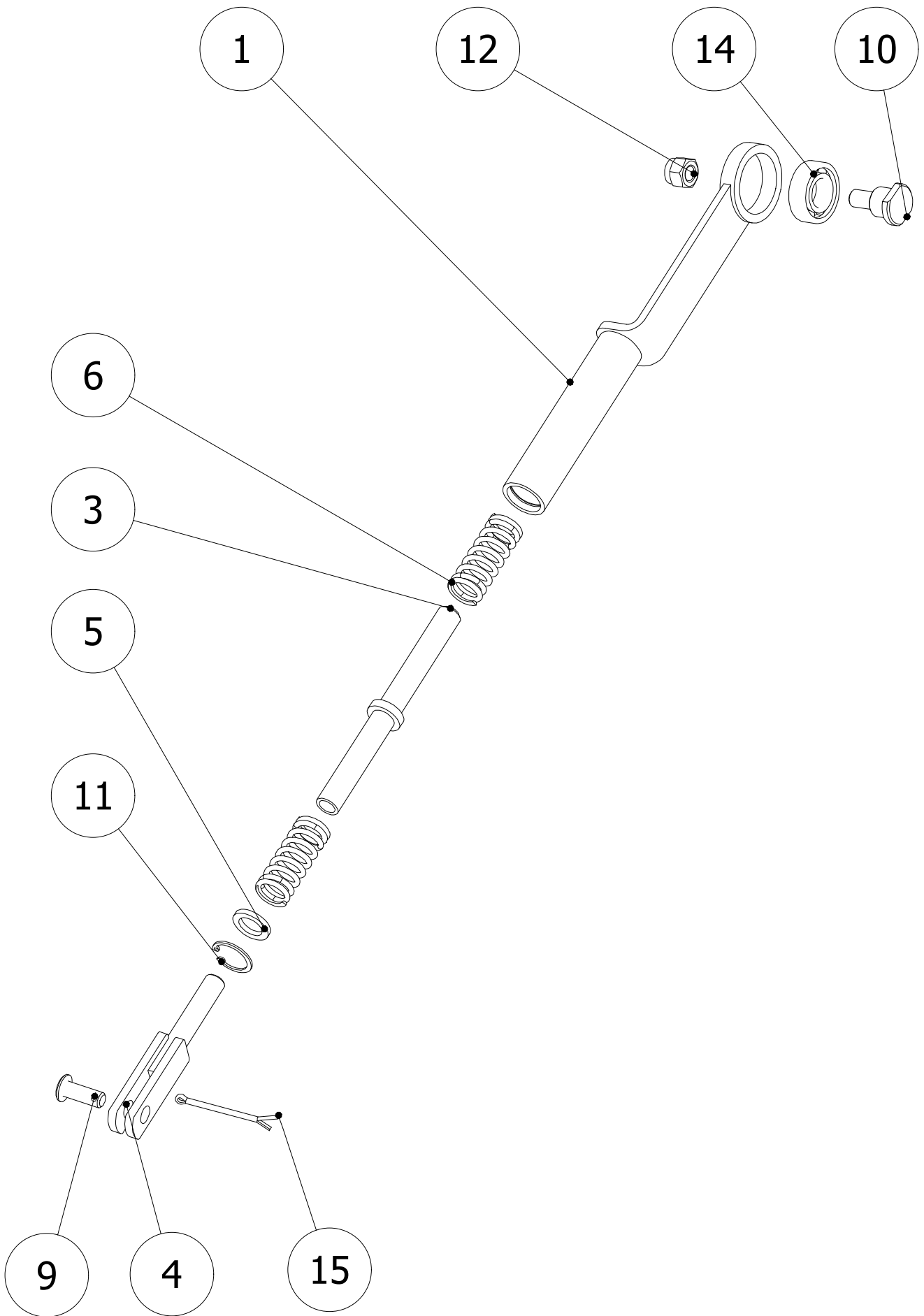

Mechanismus čišťení	POZICE	POPIS	KÓD	ČÍSLO SOUČÁSTI	POČET KS	POZNÁMKY
	1	ÓJE ČISTĚNÍ	PKTX0167	424.S01.000.A4	1	
	3	ČEP VEDENÍ	PKTX0170	424.003.000.A4	1	
	4	VIDLICE	PKTX0171	424.S04.000.A4	1	
	5	VÍČKO	MHVT0139	424.005.000.A4	1	
	6	PRUŽINA TLAČNÁ	MRUZ0065		2	
	9	ČEP 1	PKTX0175	424.009.000.A4	1	

Mechanismus čišění	POZICE	POPIS	KÓD	ČÍSLO SOUČÁSTI	POČET KS	POZNÁMKY
	10	ČEP	PKTX0176	424.010.000.A4	1	
	11	Pojistné kroužky pro díry - 22	MSRX0014	CSN 02 2931	1	
	12	Samojistné šestihřanné matice - M10	MSMX0006	ISO 7041	1	
	14	Kuličková ložiska jednořadá - 6003 2RS	MRUZ0048	CSN 02 4630	1	
	15	Závlačka - 3,2 x 50	MSRX0059	ISO 1234	1	

POHON ČISTĚNÍ

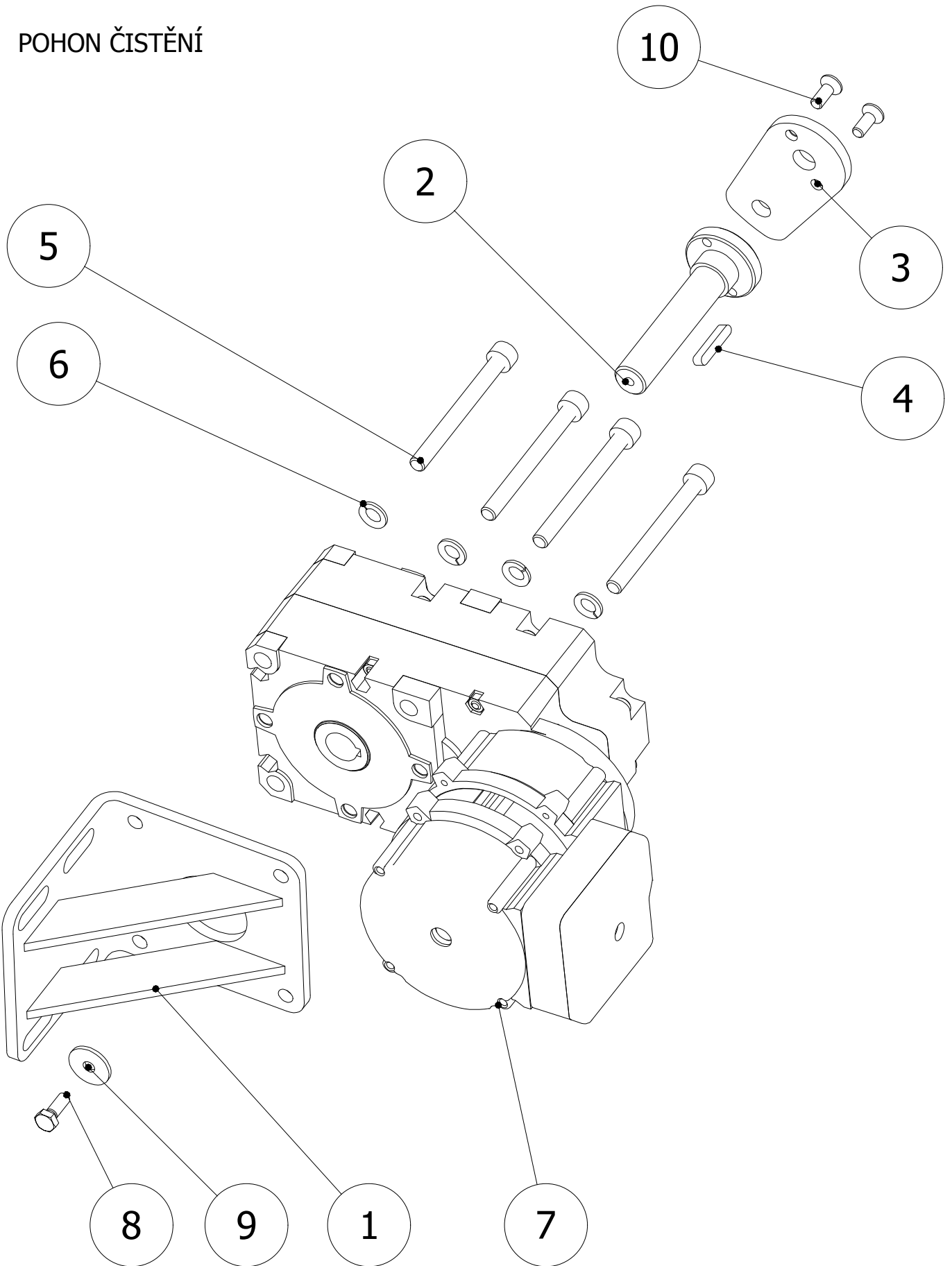

POHON ČISTĚNÍ TAHŮ	POZICE	POPIS	KÓD	ČÍSLO SOUČÁSTI	POČET KS	POZNÁMKY
	1	DRŽÁK MOTORU ABM	PKTX0216	446.S01.000.A3	1	
	2	UNAŠEČ	PKTX0218	446.002.000.A3	1	
	3	PÁKA	PKTX0179	397.S25.003.A4	1	
	4	Těsné pero - A 5 x 5 x 30	MSRX0007	DIN 6885	1	
	5	Šroub s válcovou hlavou - M8 x 80	MSSX0045	DIN 912	4	
	6	Pružná podložka - A8	MSPX0006	DIN 128	4	

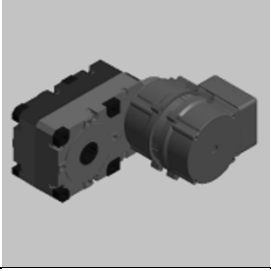
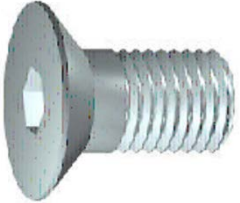
POHON ČISTĚNÍ TAHŮ	POZICE	POPIS	KÓD	ČÍSLO SOUČÁSTI	POČET KS	POZNÁMKY
	7	Motor EPO MRB 0,12kW/2p	MEMP0037		1	
	8	Šestihranný šroub - M6 x 16	MSSX0015	DIN 933	1	
	9	Podložka 6	MSPX0002	DIN 440R	1	
	10	Šroub se zápusťnou hlavou - M6 x 16	MSSX0096	DIN 7991	2	
	11	Kabel SIHF 3G 1	MEKV0003		1.5m	

POHON VYMETÁNÍ

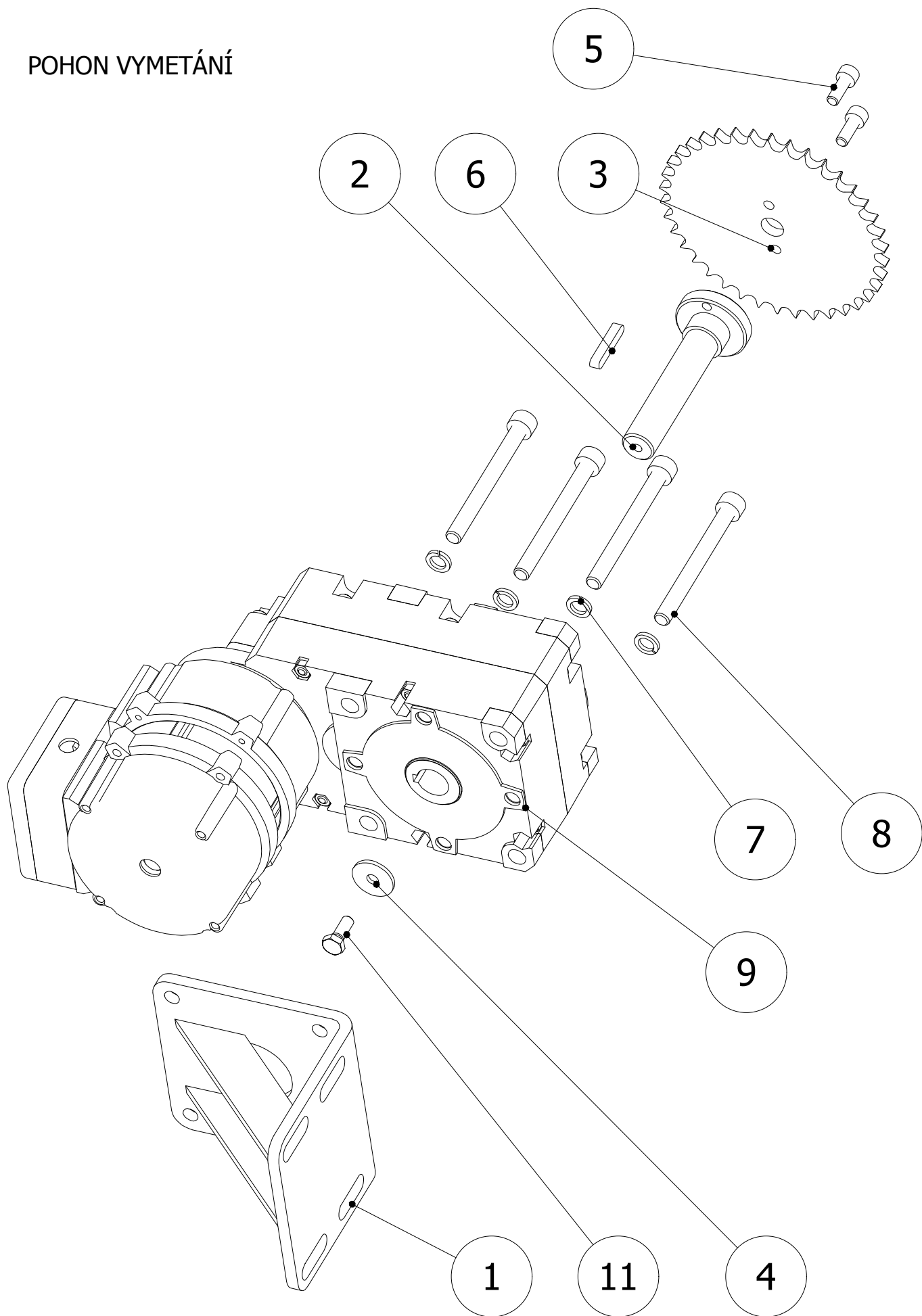

POHON VYMETÁNÍ POPELA KP62	POZICE	POPIS	KÓD	ČÍSLO SOUČÁSTI	POČET KS	POZNÁMKY
	1	DRŽÁK MOTORU ABM	PKTX0216	446.S01.000.A3	1	
	2	UNAŠEČ	PKTX0218	446.002.000.A3	1	
	3	KOLO ŘETĚZOVÉ ÚPRAVA	PKTX0225	446.003.000.A4	1	
	4	Podložka 6	MSPX0011	DIN 440R	1	
	5	Šroub s válcovou hlavou - M6 x 16	MSSX0098	ISO 4762	3	
	6	Těsné pero - A 5 x 5 x 30	MSRX0007	DIN 6885	1	

POHON VYMETÁNÍ POPELA KP62	POZICE	POPIS	KÓD	ČÍSLO SOUČÁSTI	POČET KS	POZNÁMKY
	7	Pružná podložka - 8	MSPX0006	DIN 7980	4	
	8	Šroub s válcovou hlavou - M8 x 80	MSSX0045	DIN 912	4	
	9	Motor EPO MRB 0,06kW/4p	MEMPO035		1	
	10	Šestihranný šroub - M6 x 16	MSSX0015	DIN 933	1	
	11	ŘETĚZ 06 B-1, 113 ČLÁNKŮ (3.8x7.32)	MRUZ0142		1	
	12	ČLÁNEK SPOJOVACÍ JEDNOŘ.	MRUZ0041		1	
	13	KABEL SIHF 3G 1	MEKV0003		1,2m	

ELEKTRO

KÓD	POPIS	MNOŽSTVÍ
MEKV0003	Kabel SIHF 3G 1	3,44 m
MEKV0006	Kabel H07 V-K 2.5 zž.	0,176 m
MEKV0007	Kabel SIHF 3x1.5	1,0 m
MEKV0011	Kabel H03VV-F 2x0,5	1,0 m
MEKV0027	Kabel H05VV-F 3G 1,5	1,0 m
MEKV0037	Kabel H07V-K 1,5 zž	3,0 m
MEKV0047	Šňůra FLEX H05VV-F 3x1,5 5m	1,0 ks
MEKV0054	Kabel CSSS 2Dx1/VO5SS-F/ silikon	1,0 m
MEKV0065	Kabel LiYY 4x0,14	5,0 m
MEKV0070	Kabel H05VV-F 4G1,5B	4,5 m
MEKV0071	Kabel H07V-K 1,5 sv.modr	2,5 m
MEKV0072	Kabel H07V-K 1,5 černý	3,0 m
MERX0003	Objímka plochá BF-F 608P	8,0 ks
MERX0004	Dutinka lis. DI 1.0-10 10	37,0 ks
MERX0016	Svorka WAGO 222-413	4,0 ks
MERX0020	Canon 9 V (RKP 12157)	1,0 ks
MERX0027	Trubička smršť. 3,2/1,6 SB/PBF-1/8	0,05 m
MERX0030	Objímka plochá RF-F 608P	3,0 ks
MERX0043	Canon sada matic CTB	1,0 ks
MERX0051	Vývodka PG 9 s matkou	16,0 ks
MERX0067	Přichytka PKB-BS 27x27mm přírodní samolepící	3,0 ks
MERX0073	Svorka WAGO 222-415	1,0 ks
MERX0078	Štítek uzemění malý	4,0 ks
MERX0126	Oko lisovací RF-M4	6,0 ks
MERX0151	Spirála svazkovací SPC10	1,0 m
MERX0158	Pásek vázací 200/3,6	8,0 ks
MERX0205	Vývodka PG 7	9,0 ks
MERX0221	Kolík ploch.přístroj. SEZC7202-00/4/100	4,0 ks
MERX0237	Konektor RJ 45-8/8 C5 dr vidlice	1,0 ks
MERX0282	Konektor RJ 45-8 Cat.5e UTP	1,0 ks
MERX0529	Kolík dvojtý 7242-00/5/4	1,0 ks
MERX0581	Filtr odrušovací MIFLEX FP-250/16	1,0 ks
MERX0621	Matka Pg 7 sv. šedá	9,0 ks
MERX0631	Konektor 2,5 / 3 green SIGMATEK	16,0 ks
MERX0632	Konektor 1,5 / 2 green SIGMATEK	15,0 ks
MERX0633	Konektor 2,5 / 2 green SIGMATEK	1,0 ks
MERX0634	Konektor 2,5 / 4 green SIGMATEK	4,0 ks
MERX0635	Konektor 1,5 / 4 green SIGMATEK	1,0 ks
MERX0636	Konektor 1,5 / 3 green SIGMATEK	1,0 ks
MERX0641	Kryt P - Canon 9	1,0 ks
MERX0648	Spirála svazkovací SPC15	0,5 m
MERX0661	Buž. smrš. SB 3,2/1,6 Mo modrá	0,06 m
MERX0662	Zástrčka ST18 -3 pol.č. Wieland	1,0 ks
METRO071	Deska základní HZS 521-G	1,0 ks
METRO072	Modul expandér HZS 532-1	1,0 ks
METRO083	Snímač teploty příložený KS 154A KTY 81-110, 3,5m	2,0 ks
METRO085	Snímač teploty TG8-55 KTY 81-110, 1,5m voda	1,0 ks

KÓD	POPIS	MNOŽSTVÍ
METR0087	Snímač teploty pro ven. KS 114B, KTY 81-110	1,0 ks
METR0108	Snímač teploty TR 050J-x TCK,silicon zelený 1,4m	1,0 ks
MREZ0012	Etiketa stříbrná 210x297	1,0 ks
MRUZ0211	FlaschDisk USB 2,0 Sandisk Cruzer Fit 8GB	1,0 ks
MRUZ0219	Průchodka 24,9 x 1,6	1,0 ks
MRUZ0220	Podložka tlum. 10x10x2,5 čtvercová 35604-0	5,0 ks
MRUZ0272	Zátka antivibrační 1/2 BSP - velikost 8	1,0 ks
MRUZ0274	Zátka souběžná 46.1MM č.465668	3,0 ks
MRUZ0275	Fólie laminovací A4	1,0 ks
MTBX0033	Páska oboustranně lepící š.=15mm	0,02 ks
PKEX0020	Rozvodnice zapalování KP 62S/82S	1,0 ks
PKEX0038	Kabeláž KP 52S,62S-2,5 m	1,0 ks

PONAST spol. s r.o
Na Potůčkách 163
757 01 Valašské Meziříčí

ČESKÁ REPUBLIKA

www.ponast.cz

tel.: 571 688 111*, 800 700 068

e-mail: servis@ponast.cz