



katalog náhradních dílů
automatického kotle
KP 82S

PONAST spol. s r.o
Na Potůčkách 163
757 01 Valašské Meziříčí
ČESKÁ REPUBLIKA
tel.: 571 688111*
e-mail: ponast@ponast.cz

aktualizace: 05/12/2018





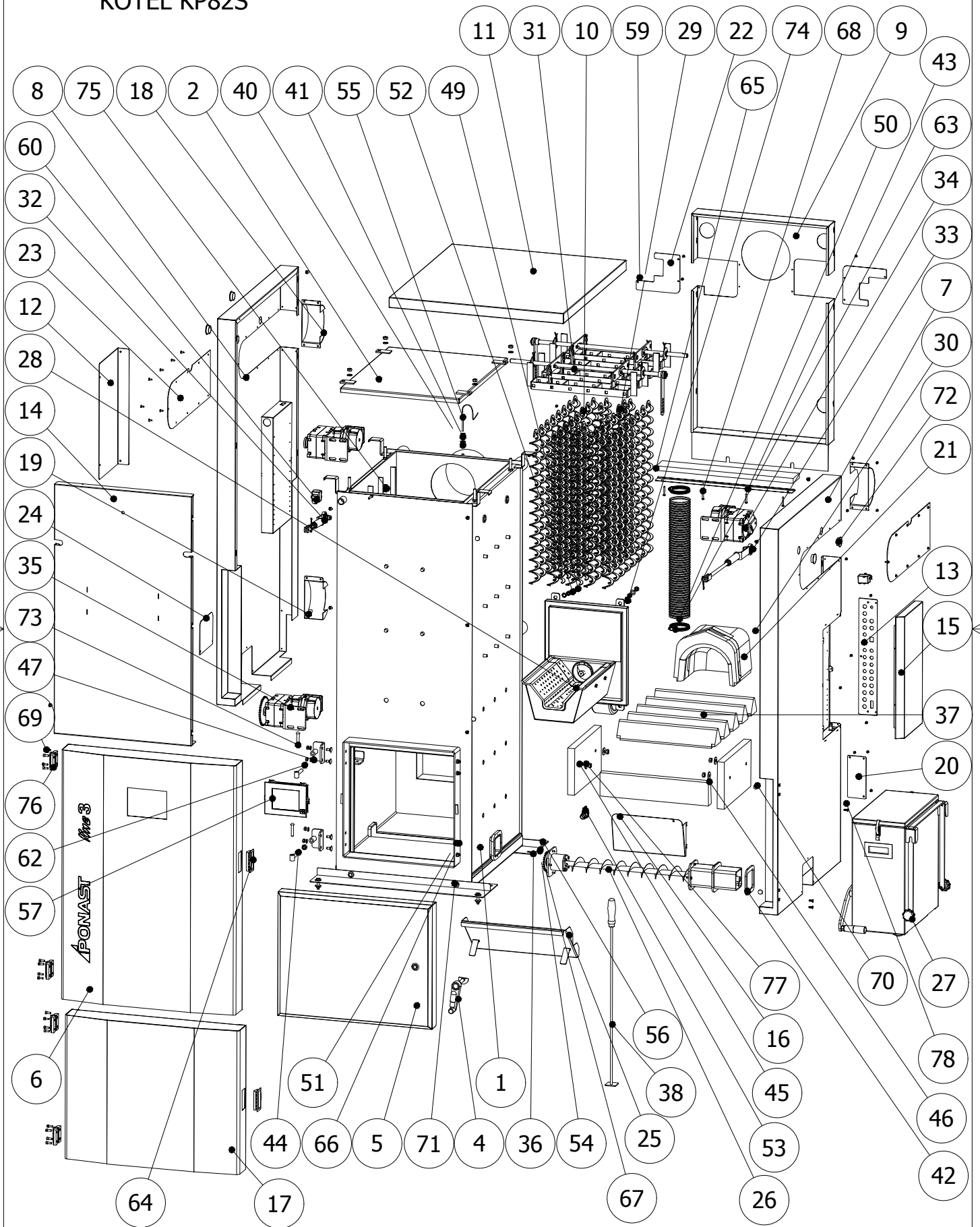



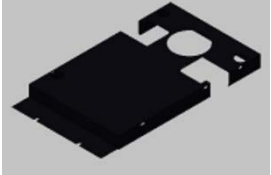
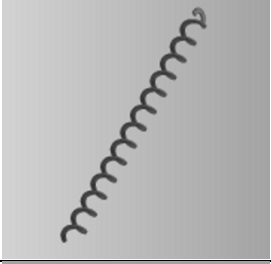
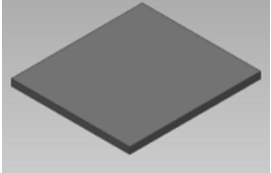
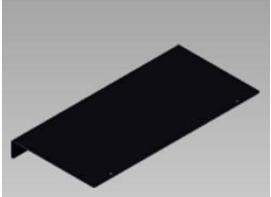
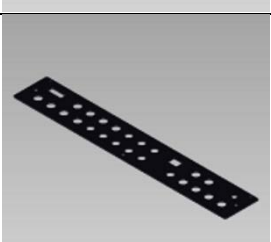

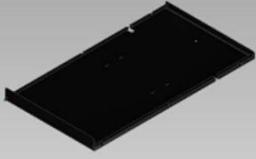
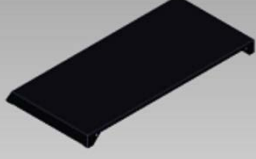

KOTEL KP82S





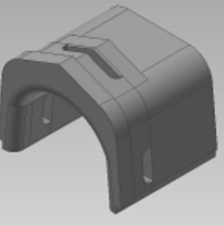

KOTEL KP82S	POZICE	POPIS	KÓD	ČÍSLO SOUČÁSTI	POČET KS	POZNÁMKY
	1	TĚLESO KOTLOVÉ KP82	PKXX8201	749.S01.000.A1	1	Sestava
	2	VÍKO KOTL. TĚLESA KP82	KKTX0049	749.S12.000.A2	1	Sestava
	4	KLIKA x2	KKTX0019	338.S04.000.A3	1	Sestava
	5	DVÍŘKA KP62	KKTX0034	338.S05.000.A3	1	Sestava
	6	ČELO KP62	PKMBB0159	723.S03.000.A3	1	
	7	BOČNICE PRAVÁ	PKMD0176 PKMD0176L	749.S06.000.A3	1	PRAVÝ LEVÝ

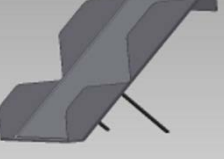
KOTEL KP82S	POZICE	POPIS	KÓD	ČÍSLO SOUČÁSTI	POČET KS	POZNÁMKY
	8	BOČNICE LEVÁ	PKMD0177 PKMD0177L	749.S07.000.A3	1	PRAVÝ LEVÝ
	9	KRYT ZADNÍ	PKMD0179	749.011.000.A3	1	
	10	TURBULÁTOR PLOCHÝ 645mm	MRUZ0223	749.014.000.A4	40	
	11	VÍKO HORNÍ- SVAŘENEC	PKMX0178	749.S09.000.A4	1	
	12	KRYT KRABICE	PKMD0168	723.008.000.A3	1	
	13	DESKA	PKMD0143	723.005.000.A4	1	

KOTEL KP82S	POZICE	POPIS	KÓD	ČÍSLO SOUČÁSTI	POČET KS	POZNÁMKY
	14	VZPĚRA 1	PKMD0166	723.006.000.A4	1	
	15	KRYT JEDNOTKY BOČNÍ	PKMD0142	726.008.000.A3	1	
	16	ŠUPLÍK	PKMD0169	723.010.000.A3	1	
	17	KRYT DVEŘÍ KP62	PKMBB0162	723.S04.000.A3	1	
	18	KRYT ČISTĚNÍ	PKMD0081	397.S13.000.A3	2	
	19	KRYT VYMETÁNÍ	PKMD0183 PKMD0232	749.S14.000.A3	1	PRAVÝ LEVÝ

KOTEL KP82S	POZICE	POPIS	KÓD	ČÍSLO SOUČÁSTI	POČET KS	POZNÁMKY
	20	ZÁSLEPKA MOTORU	PKMD0184	749.013.000.A4	1	
	21	REFLEKTOR KP62 PODKOVA KP62	MTKE0013 MTKE0014	332.100.000.A3	1 1	
	22	KRYTKA ZAD	PKMD0102	338.S07.007.A4	2	
	23	KRYTKA POHONU ČISTĚNÍ	PKMD0217	749.S07.006.A3	2	
	24	KRYTKA POHONU VYMETÁNÍ 1	PKMD0105	338.S06.005.A3	1	
	25	LOPATKA KP62	PKTX0174	334.009.000.A3	1	

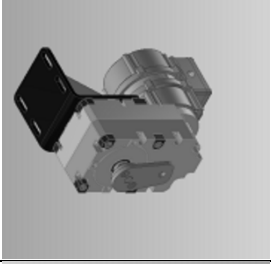
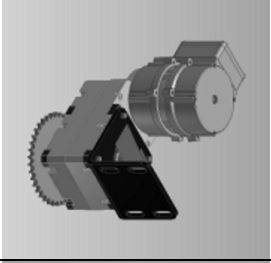
KOTEL KP82S	POZICE	POPIS	KÓD	ČÍSLO SOUČÁSTI	POČET KS	POZNÁMKY
	26	VYMET.POPELE KP82	KKTX0060	749.S26.000.A2	1	Sestava
	27	POPELNICE 45L	KKTX0045 KKTX0027	568.000.000.A3	1	Sestava PRAVÁ LEVÁ
	28	HOŘÁK 80KW EPO	KHXX8004	752.V01.000.A3	1	Sestava
	29	TURBULÁTOR PLOCHÝ 645mm	MRUZ0178	713.000.000.A4	8	
	30	KLÍČ	PKRX0008	286.000.000.A4	14	
	31	ČISTĚNÍ VÝMĚNÍKU KP82	KKTX0048	753.000.000.A3	1	Sestava

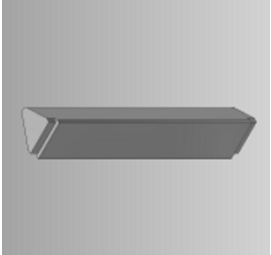
KOTEL KP82S	POZICE	POPIS	KÓD	ČÍSLO SOUČÁSTI	POČET KS	POZNÁMKY
	32	MECHANISMUS ČISTĚNÍ 1	KKTX0050	749.S10.000.A3	1	Sestava
	33	MECHANISMUS ČISTĚNÍ 2	KKTX0051	749.S02.000.A3	1	Sestava
	34	POHON ČISTĚNÍ TAHŮ	KKTX0041	727.S25.000.A3	2	Sestava
	35	POHON VYMETÁNÍ KP82S	KKTX0061	749.S27.000.A3	1	Sestava
	36	DRŽÁK KOTLE KP50,51	PKRX0046	356.000.000.A3	2	
	37	KERAMIKA TROJÚHELNÍKOVÁ	MTKE0135	420.900.000.A3	5	

KOTEL KP82S	POZICE	POPIS	KÓD	ČÍSLO SOUČÁSTI	POČET KS	POZNÁMKY
	38	ŠKRABKA	PKRX0001	001.S32.000.A4	1	
	40	REDUKCE DÍL 1	PKRX0062	792.001.000.A4	1	
	41	REDUKCE DÍL 2	PKRX0063	792.002.000.A4	1	
	42	TĚSNĚNÍ	PKTX0157	334.S08.005.A4	1	
	43	DRŽÁK SIBRALU	PKMD0120	338.056.000.A4	1	
	44	PANT DVÍŘEK	PKTX0037	005.S05.S03.A4	2	

KOTEL KP82S	POZICE	POPIS	KÓD	ČÍSLO SOUČÁSTI	POČET KS	POZNÁMKY
	45	KERAMIKA NA DVÍŘKA	MTKE0004	001.005.008.A4	2	
	46	KERAMIKA NAD DV.KP50-62	MTKE0001	338.053.000.A4	1	
	47	PANT DÍL 2	PKTX0238	338.S01.S43.A3	2	
	48	SIBREX 300 20x150x517	MTIZ0010		1	
	49	Šestihránné matice - M10	MSMX0041	ISO 4032	15	
	50	HADICE FLEXADUR PU-1NO DN 80x1000	MRUZ0018		1	

KOTEL KP82S	POZICE	POPIS	KÓD	ČÍSLO SOUČÁSTI	POČET KS	POZNÁMKY
	51	Ploché podložky - 8	MSPX0001	ISO 7089	32	
	52	Ploché podložky - 10	MSPX0005	ISO 7089	8	
	53	VENTIL VYPOŠTĚCÍ S PÁČKOU	MRUZ0024		1	
	54	Šestihranný šroub - M8 x 40	MSSX0027	DIN 933	4	
	55	Snímač teploty TR 050J-x TCK, 1,4m	METRO108		1	
	56	Podložka - 8,4	MSPX0008	DIN 9021 - 8,4	12	

KOTEL KP82S	POZICE	POPIS	KÓD	ČÍSLO SOUČÁSTI	POČET KS	POZNÁMKY
	57	TERMINÁL DOTYKOVÝ HZS 555-S	METR0073		1	
	59	Šrouby samořezné - ST 4,8 x 13	MSSX0118	ISO 7049	50	ČERNÝ ZINEK
	60	HAVARIJNÍ TERMOSTAT LY 26 I	METR0049		2	
	62	Šestihranné matice - M12	MSMX0007	ISO 4032	2	
	63	SPONA HADICOVÁ 70- 90 NEREZ	MRUZ0089		2	
	64	Rukojeť EPR_90_Pf_C1	MRUZ0205		2	

KOTEL KP82S	POZICE	POPIS	KÓD	ČÍSLO SOUČÁSTI	POČET KS	POZNÁMKY
	65	SIBREX 20x80x594	MTIZ0018		1	
	66	Šroub s půlk. hl.a 4hr.kr. - M8 x 20	MSSX0207	ISO 8677	8	
	67	Šestihránné matice - M8	MSMX0016	ISO 4032	36	
	68	Šroub do plechu - ST4,8 x 38	MSSX0042	ISO 7049	70	
	69	Šroub s válcovou hlavou - M6 x 16	MSSX0224	DIN 912	16	
	70	MAGNET 18x2	MRUZ0077		4	

KOTEL KP82S	POZICE	POPIS	KÓD	ČÍSLO SOUČÁSTI	POČET KS	POZNÁMKY
	71	Šestihranný šroub - M8 x 20	MSSX0002	DIN 933	4	
	72	ZÁSLEPKA ČERNÁ 35-38mm	MRUZ0228		4	
	73	NÝT 10x50 Fe	MSRX0032	DIN 660	2	
	74	Vějířová pojistná podložka - A 10,5	MSPX0003	DIN 6798 A	2	
	75	Ploché podložky - 16	MSPX0022	ISO 7089	3	
	76	Pant ELESA CFA.65-SL-H-V	PKTX0295		4	

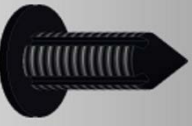
KOTEL KP82S	POZICE	POPIS	KÓD	ČÍSLO SOUČÁSTI	POČET KS	POZNÁMKY
	77	Podložka - 10,5	MSPX0004	DIN 9021	4	
	78	Nýt zářecí pr.5mm 27024050	MSSX0125		4	

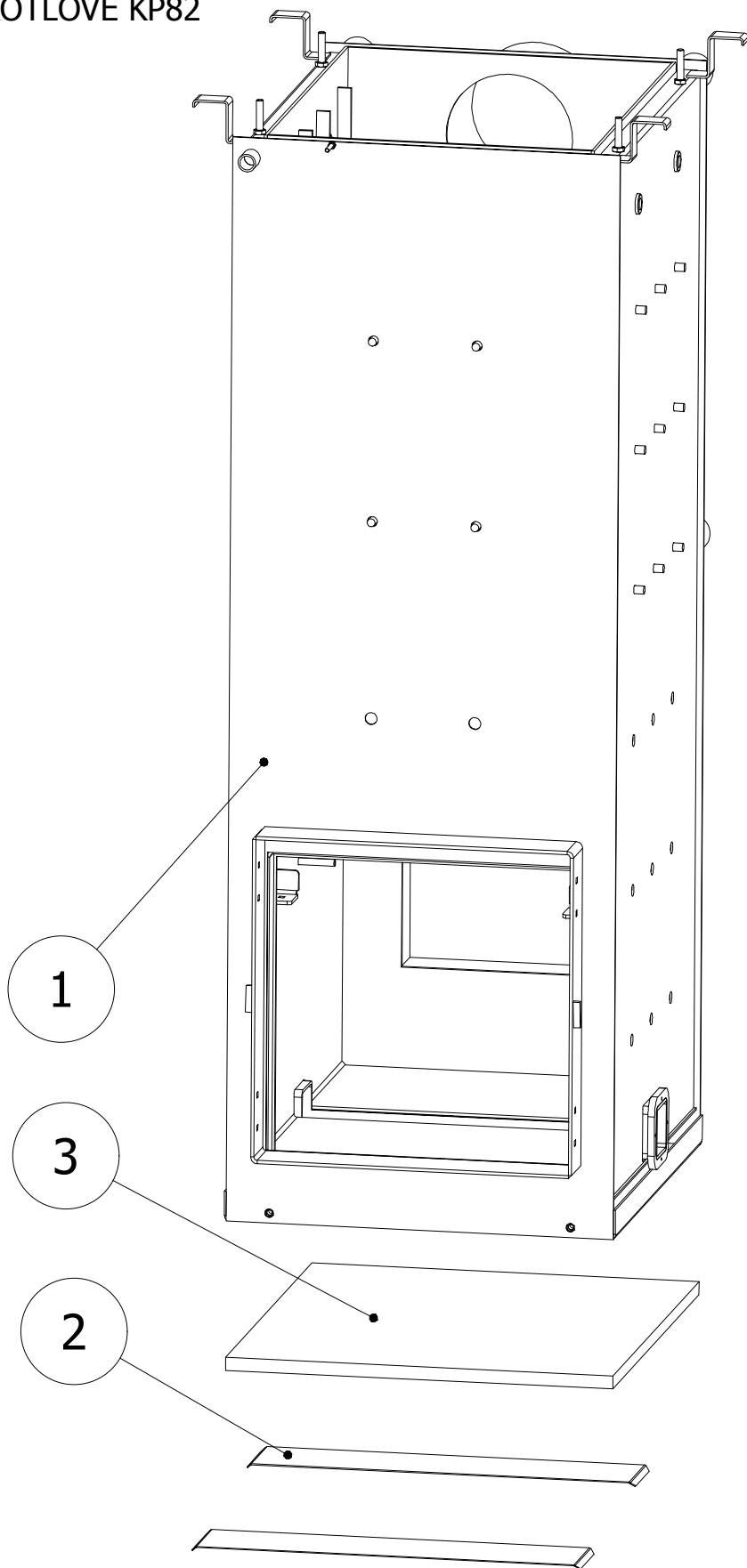

TĚLESO KOTLOVÉ KP82

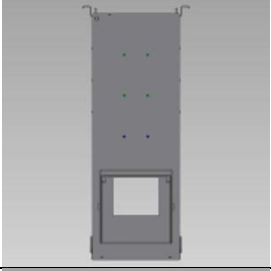
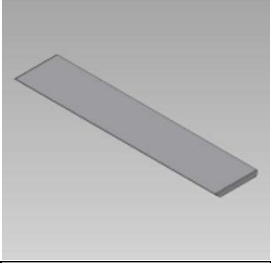
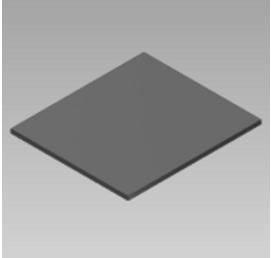

TĚLESO KOTLOVÉ KP82	POZICE	POPIS	KÓD	ČÍSLO SOUČÁSTI	POČET KS	POZNÁMKY
	1	TĚLESO KOTLOVÉ KP82	PKXX8201	749.S01.000.A1	1	
	2	DRŽÁK IZOLACE KP51, KP82	PKTX0348		2	
	3	IZOLACE 20x586x665	PKTX0345		1	

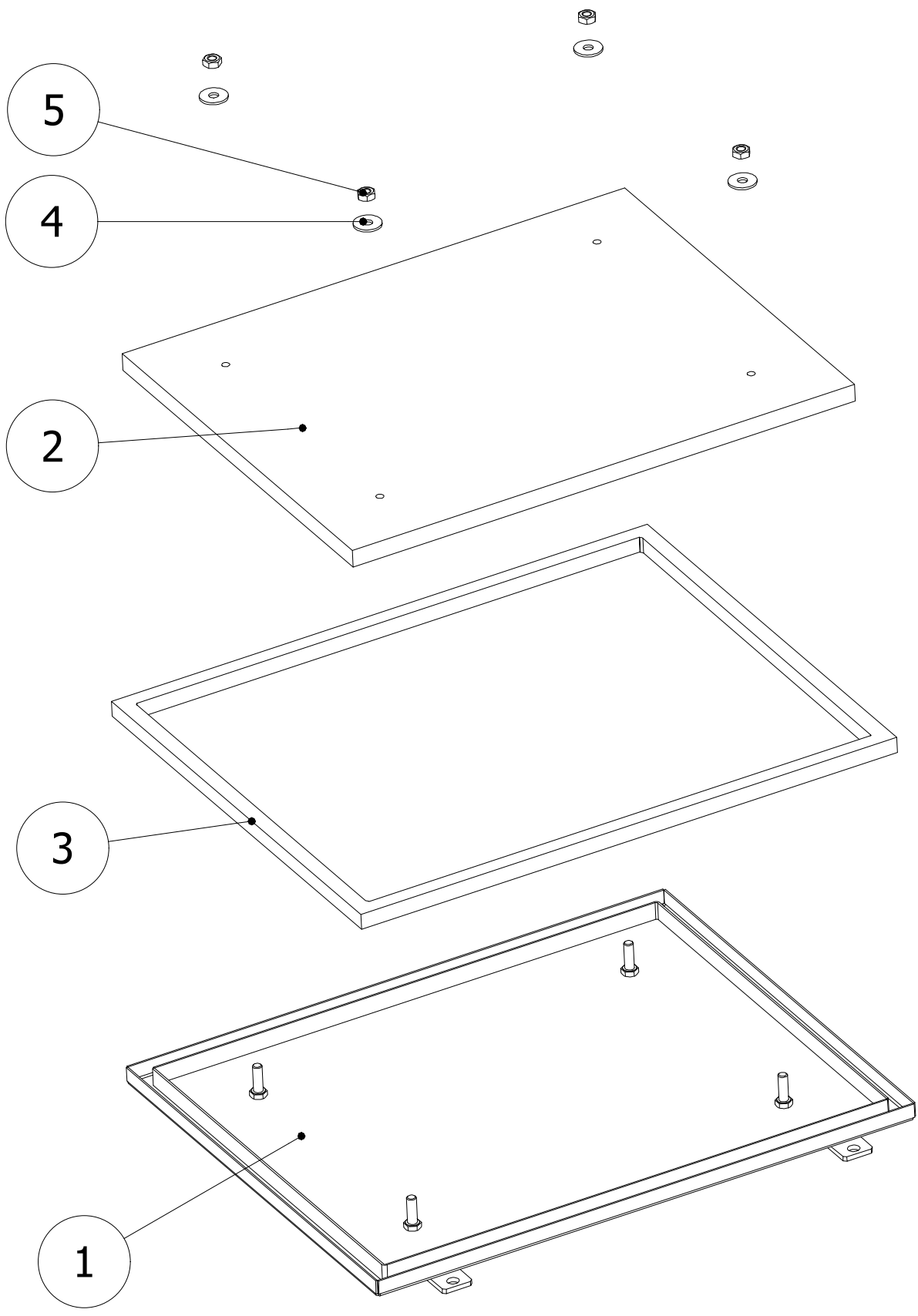
VÍKO



VÍKO KOTL.TĚLESA KP82	POZICE	POPIS	KÓD	ČÍSLO SOUČÁSTI	POČET KS	POZNÁMKY
	1	VÍKO KOTL.TĚLESA KP82	PKTX0296	749.012.000.A3	1	
	2	SIBREX 140 20x473x598	MTIZ0022		1	
	3	ŠŇŮRA TĚSNÍCÍ 18x18	MRUZ0133		2.23m	
	4	Podložka - 10,5	MSPX0004	DIN 9021	4	
	5	Šestihránná matice - M10	MSMX0002	DIN 934	4	

KLIKA

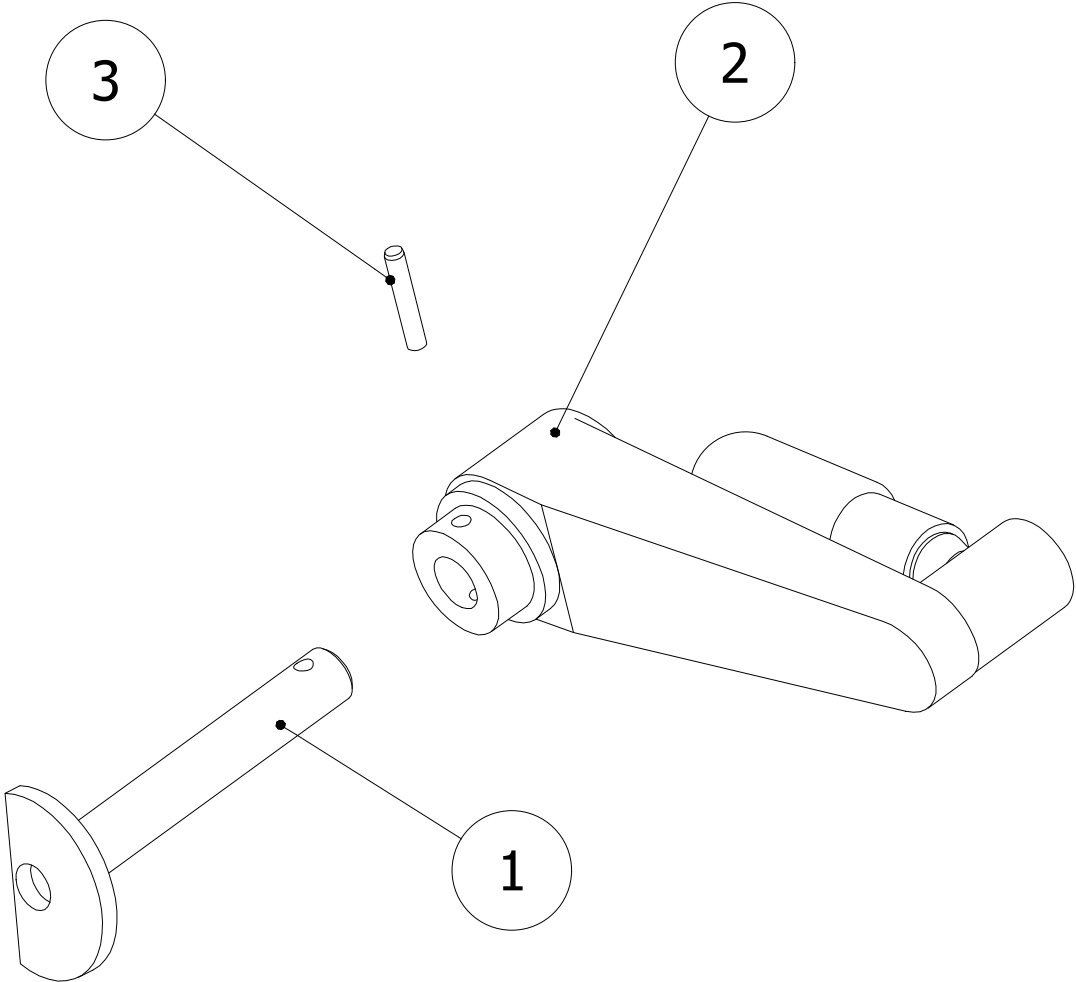

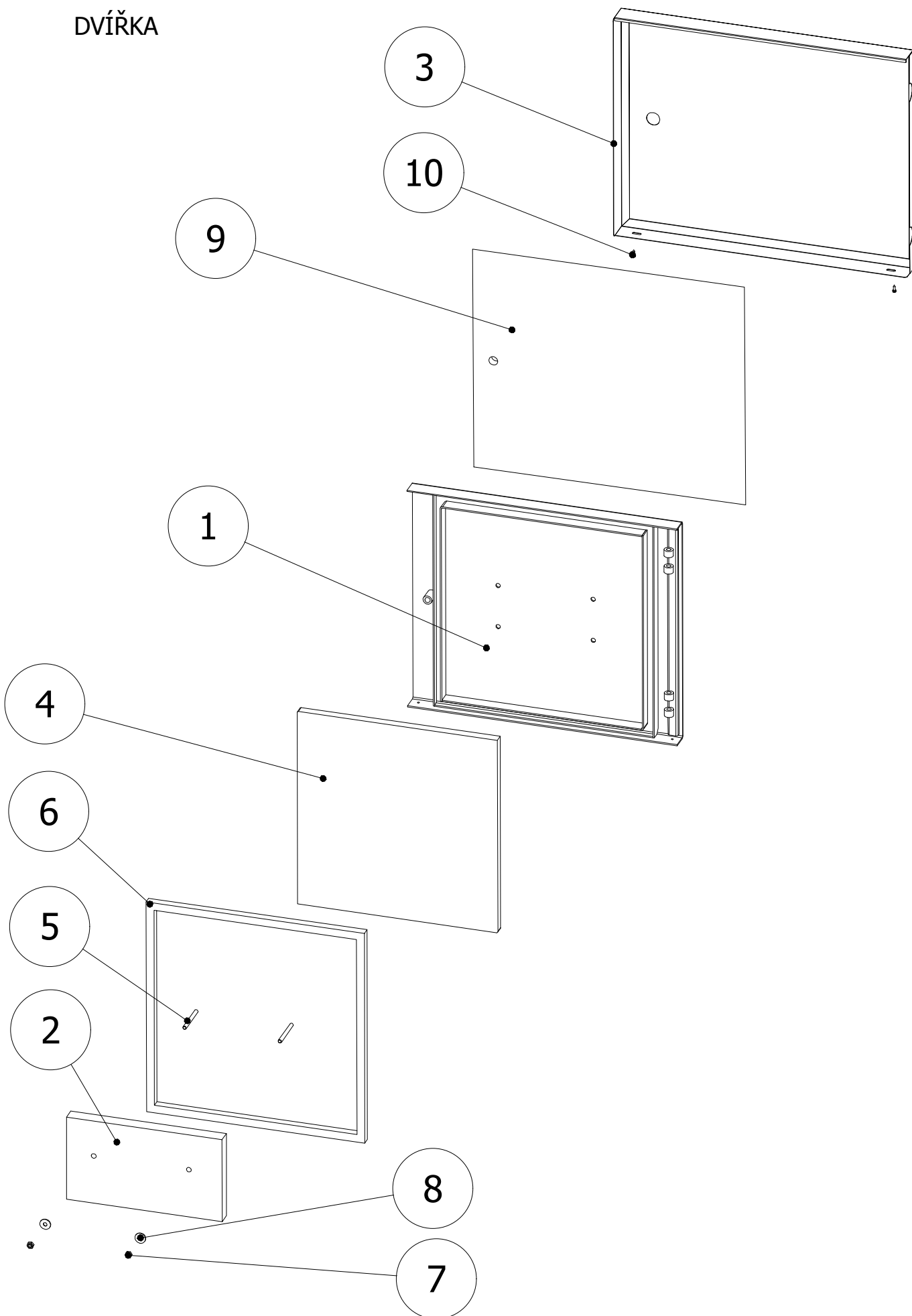

KLIKA	POZICE	POPIS	KÓD	ČÍSLO SOUČÁSTI	POČET KS	POZNÁMKY
	1	DŘÍK KLIKY	PKTX0118	054.S04.001.A3	1	
	2	KLIKA SKLAPOVACÍ ELESA GANTER	MRUZ0117	MT.100-AT+IR	1	KÓD 44317
	3	Kolík - 4 x 24 - A (kalený)	MSRX0003	ISO 8734	1	

DVÍŘKA

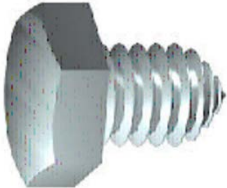

DVÍŘKA	POZICE	POPIS	KÓD	ČÍSLO SOUČÁSTI	POZICE KS	POZNÁMKY
	1	DVÍŘKA	PKTX0243	338.005.000.A3	1	
	2	KERAMIKA NA DVÍŘKA KP62	MTKE0010	338.017.000.A4	1	
	3	KRYT DVÍŘEK	PKMD0116	338.012.000.A2	1	
	4	SIBREX 300 20x457.5x467	MTIZ0008		1	
	5	TYČ ZÁVITOVÁ M8x85	PKTX0268		2	
	6	ŠŇŮRA TĚSN. 18x18	MRUZ0133		2.01m	

DVÍŘKA	POZICE	POPIS	KÓD	ČÍSLO SOUČÁSTI	POZICE KS	POZNÁMKY
	7	Šestihránná matice - M8	MSMX0016	DIN 934	2	Zn
	8	Podložka - 8,4	MSPX0008	DIN 9021	2	
	9	IZOLACE DVÍŘEK KP62 20x530x620	MTIZ0011		1	
	10	Šroub do plechu - ST4,2 x 13	MSSX0012	ISO 1479	2	

VYMETÁNÍ POPELE KP82

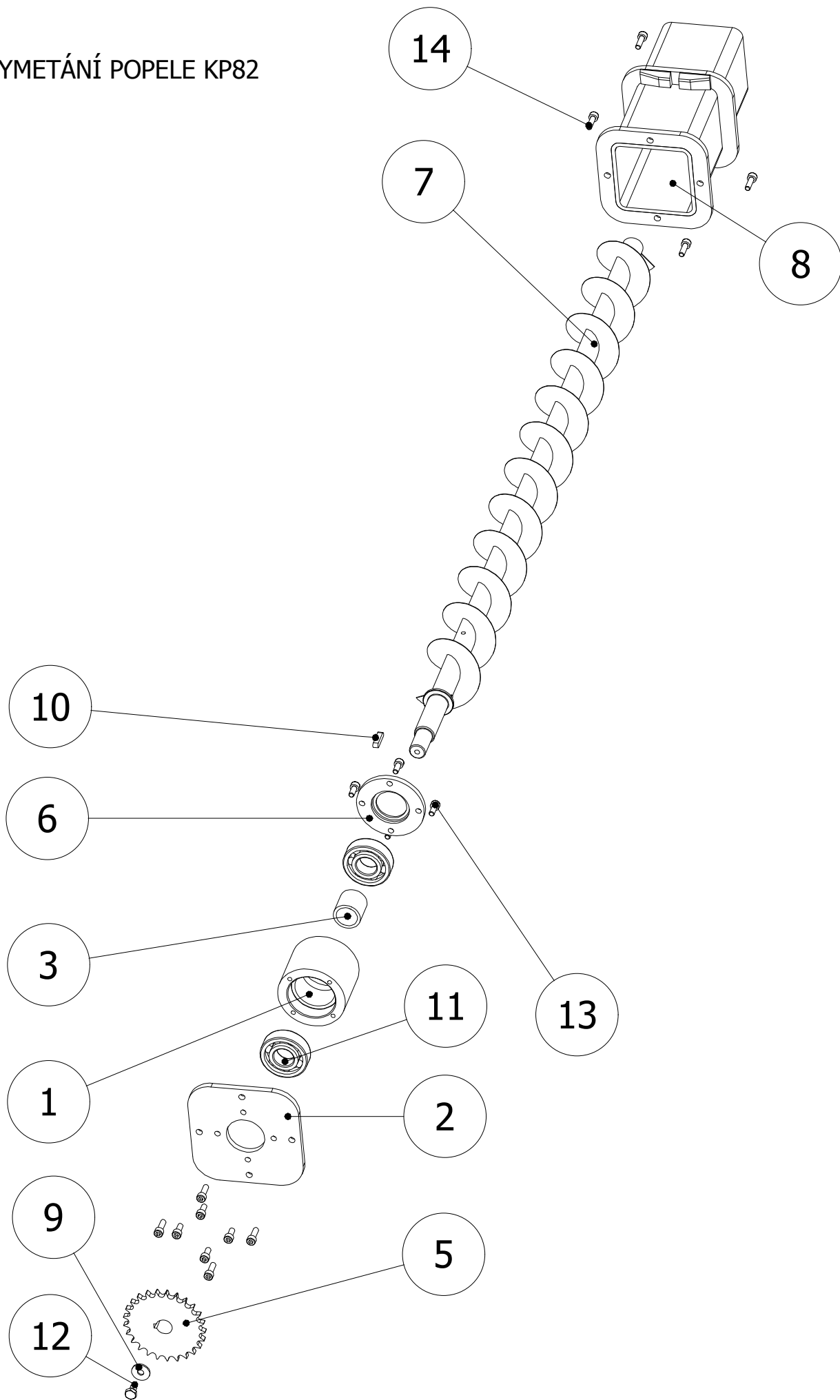

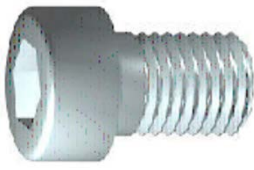

VYMET.POPELE KP82	POZICE	POPIS	KÓD	ČÍSLO SOUČÁSTI	POČET KS	POZNÁMKY
	1	NÁBOJ	PKTX0140	334.001.000.A4	1	
	2	VÍKO 1	PKTX0150	334.002.000.A4	1	
	3	DISTANCE	PKTX0440	334.003.000.A4	1	
	5	KOLO ŘETĚZOVÉ S NÁB.3/8"x7/32 "	PKTX0143	334.005.000.A4	1	
	6	VÍKO 2	PKTX0144	334.006.000.A4	1	
	7	ŠNEK	PKTX0146	334.S07.000.A3	1	

VYMET.POPELE KP82	POZICE	POPIS	KÓD	ČÍSLO SOUČÁSTI	POČET KS	POZNÁMKY
	8	VEDENÍ ŠNEKU	PKTX0153	334.S08.000.A3	1	
	9	Podložka - 6	MSPX0002	DIN 440R	1	
	10	Těsné pero - A 5 x 5 x 22	MSRX0006	DIN 6885	1	
	11	Kuličková ložiska jednořadá - 6204	MRUZ024 6	CSN 02 4630	2	
	12	Šestihranný šroub - M6 x 10	MSSX0019	DIN 933	1	Zn
	13	Šroub s válcovou hlavou - M5 x 12	MSSX0137	DIN 912	8	

VYMET.POPELE KP82	POZICE	POPIS	KÓD	ČÍSLO SOUČÁSTI	POČET KS	POZNÁMKY
	14	Šroub s válcovou hlavou - M5 x 16	MSSX0055	DIN 912	8	

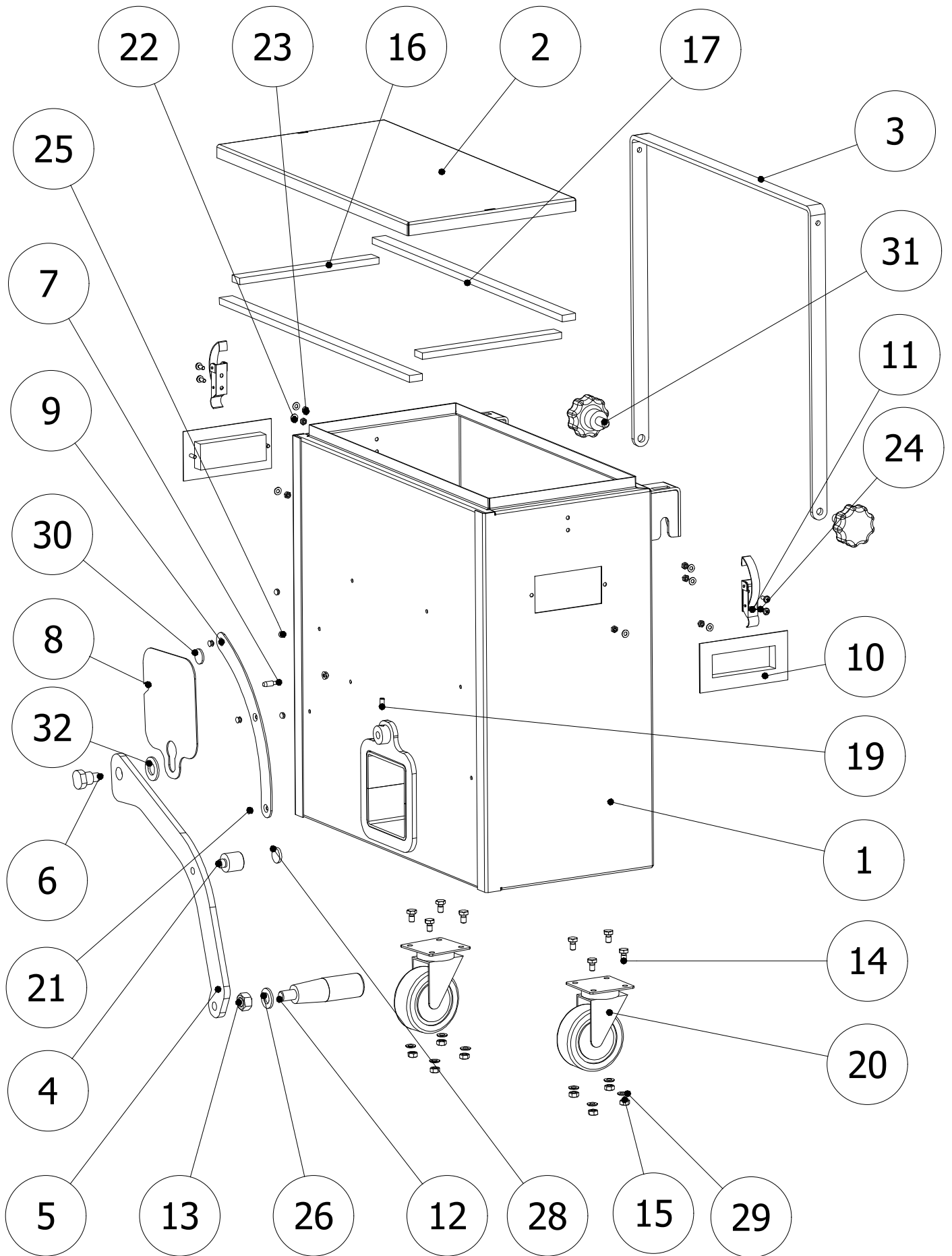
POPELNICE 45L

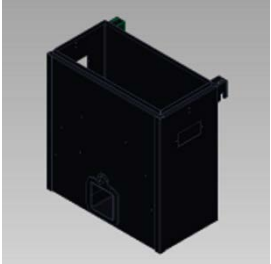
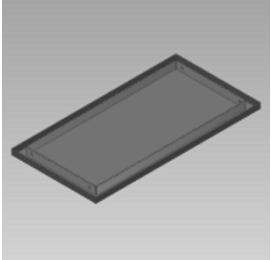
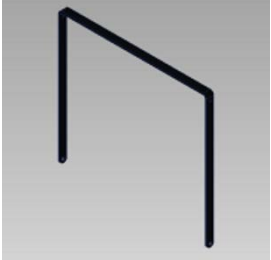
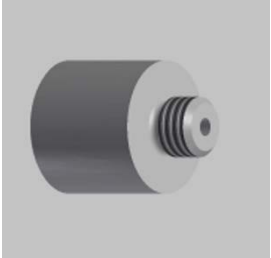

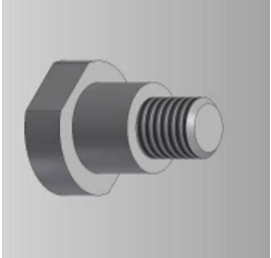



POPELNICE 45L	POZICE	POPIS	KÓD	ČÍSLO SOUČÁSTI	POČET KS	POZNÁMKY
	1	POPELNICE 45L OBAL	PKTD0182	568.S01.000.A3	1	
	2	DEKL POPELNICE 45L	PKTBB0193	568.S03.000.A4	1	
	3	DRŽADLO	PKTD0199	448.011.000.A4	1	
	4	DRŽÁK MAGNETICKÝ	PKTX0198	448.009.000.A4	1	
	5	PÁKA	PKTD0196	448.005.000.A3	1	
	6	ŠROUB	PKTX0197	448.006.000.A4	1	

POPELNICE 45L	POZICE	POPIS	KÓD	ČÍSLO SOUČÁSTI	POČET KS	POZNÁMKY
	7	DISTANCE	PKMX0037	054.009.003.A4	1	
	8	ZÁKLOPKA	MHVT0186	448.012.000.A4	1	
	9	DRÁHA	PKTX0201	448.028.000.A4	1	
	10	ÚCHYTKA ZAPUŠTĚNÁ UWAUNS	MRUZ0200	ÚCHYT	2	
	11	UZÁVĚR UP3	MRUZ0010		2	
	12	DLOUHÁ KUŽ. RUKOJEŤ	MRUZ0062	OBJ.Č.460650	1	

POPELNICE 45L	POZICE	POPIS	KÓD	ČÍSLO SOUČÁSTI	POČET KS	POZNÁMKY
	13	Šestihranné matice - M12	MSMX0007	ISO 4032	1	
	14	Šestihranný šroub - M6 x 10	MSSX0019	DIN 933	8	
	15	Šestihranné matice - M6	MSMX0001	ISO 4032	8	
	16	TĚSNĚNÍ SILIKONOVÉ 8x18-190	MRUZ0090		2	
	17	TĚSNĚNÍ SILIKONOVÉ 8x18-443	MRUZ0122		2	
	19	Šroub stavěcí M5x10	MSRX0015	ISO 7434	1	

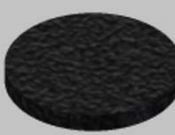
POPELNICE 45L	POZICE	POPIS	KÓD	ČÍSLO SOUČÁSTI	POČET KS	POZNÁMKY
	20	KOLO PEVNÉ EGA 075/FLP PR.75	MRUZ0056	FA.MONTAKO	2	
	21	Nýt se záp.hl. 4x8 Al	MSRX0013		3	
	22	Ploché podložky - 4	MSPX0014	ISO 7089	9	
	23	Šestihránné matice - M4	MSSX0012	ISO 4032	9	
	24	Šrouby s válč. hl. s kří. drážk. - M4 x 10	MSSX0010	ISO 7045	4	
	25	Nýt trhací 4 x 8 Al	MSRX0013	DIN 660 - A	3	



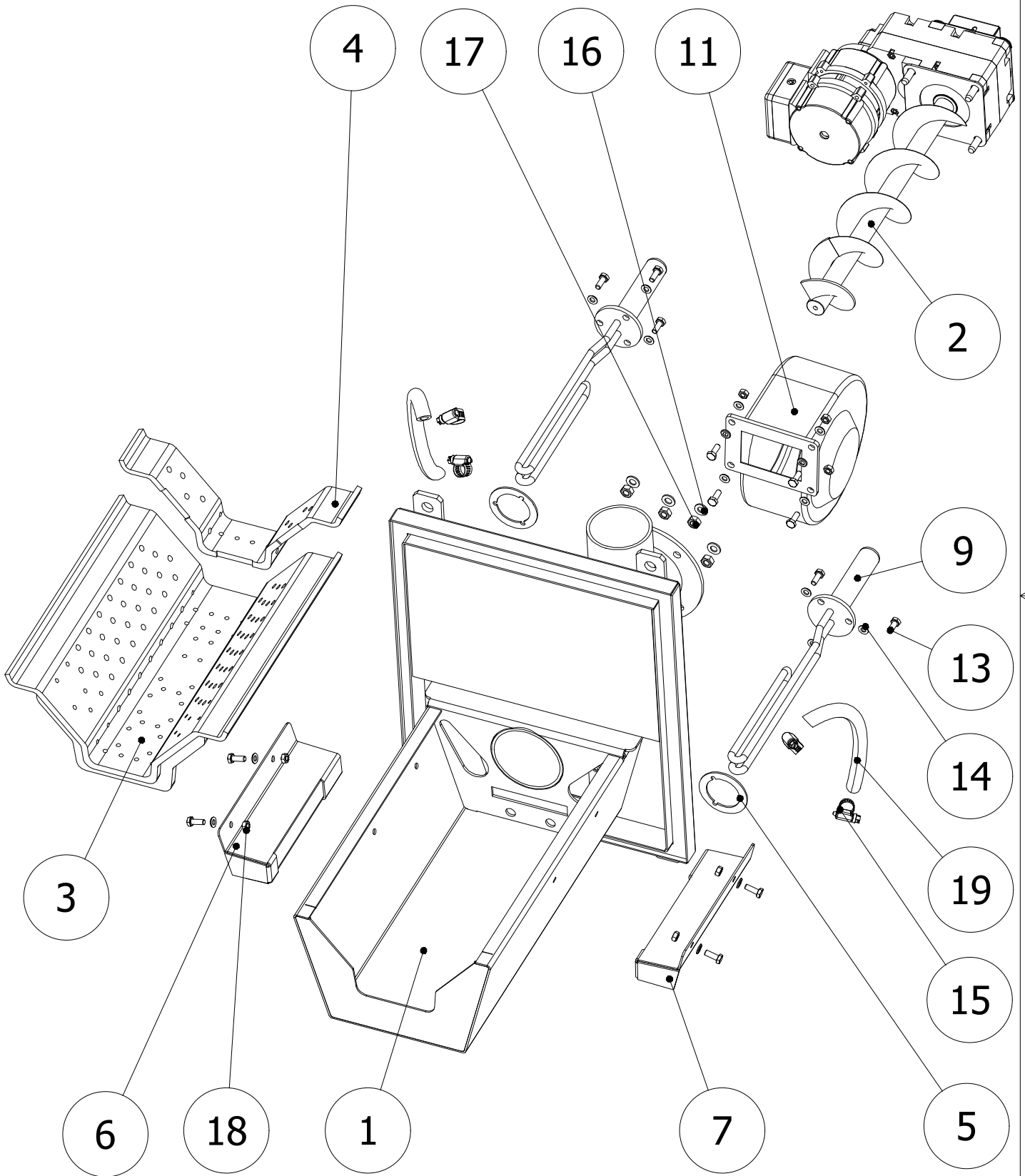

POPELNICE 45L	POZICE	POPIS	KÓD	ČÍSLO SOUČÁSTI	POČET KS	POZNÁMKY
	26	Ploché podložky - 12	MSPX0020	ISO 7089	1	
	28	MAGNET 18x3	MRUZ0088		1	
	29	Ploché podložky - 6	MSPX0026	ISO 7090	8	
	30	MAGNET 18x2	MRUZ0077		1	
	31	ŠROUB KOVOVÝ S PLAST.HLAVOU M10x17	MRUZ0032	OBJ.Č.105a-068-D/MxL	2	
	32	Podložka - A 16	MSPX0022	DIN 125	1	

HOŘÁK 80KW EPO



HOŘÁK 80KW EPO	POZICE	POPIS	KÓD	ČÍSLO SOUČÁSTI	POZICE KS	POZNÁMKY
	1	HOŘÁK 80KW SVAŘENEC+TĚSNĚNÍ +SIBREX	KHXX8002	752.001.000.A3	1	Sestava
	2	PODAVAČ P2 EPO HOŘÁKU KP80KW MK04	KHXX8005	752.S04.000.A3	1	Sestava
	3	DESKA HOŘÁKOVÁ 60KW-OCELOLITINA	MHRX0037	613.002.000.A3	1	
	4	DESKA HOŘÁK. 57mm 80KW GG20 ODLIT.	MHRX0081	752.004.000.A3	1	
	5	TĚSNĚNÍ	PHXX0115	493.021.000.A4	2	
	6	TUNEL LEVÝ	PHXX0199	752.S14.001.A3	1	

HOŘÁK 80KW EPO	POZICE	POPIS	KÓD	ČÍSLO SOUČÁSTI	POZICE KS	POZNÁMKY
	7	TUNEL PRAVÝ	PHXX0198	752.S13.001.A3	1	
	9	SPIRÁLA ZAPALOVACÍ 1000W ZAL.	MERX0139		2	
	11	VENTILÁTOR RG12S-2EP	MEVE0017		1	
	13	Šestihranný šroub - M6 x 16	MSSX0015	ISO 4017	14	Zn
	14	Ploché podložky - 6	MSPX0026	ISO 7090	16	
	15	SPONA HADICOVÁ 10-16mm	MRUZ0209		4	

HOŘÁK 80KW EPO	POZICE	POPIS	KÓD	ČÍSLO SOUČÁSTI	POZICE KS	POZNÁMKY
	16	Ploché podložky - 8	MSPX0001	ISO 7089	4	
	17	Šestihranné matice - M8	MSMX0016	ISO 4032	4	
	18	Šestihranné matice - M6	MSMX0001	ISO 4032	8	
	19	Hadice silikon. pr.17x3.5	MRUZ0210		0,6m	

HOŘÁK 80KW SVAŘENEC+TĚSNĚNÍ+SIBREX

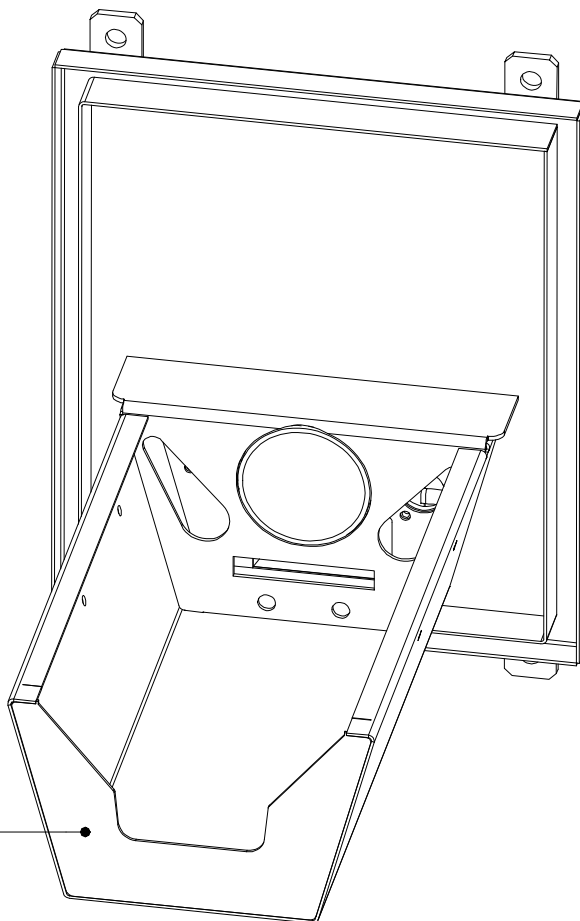

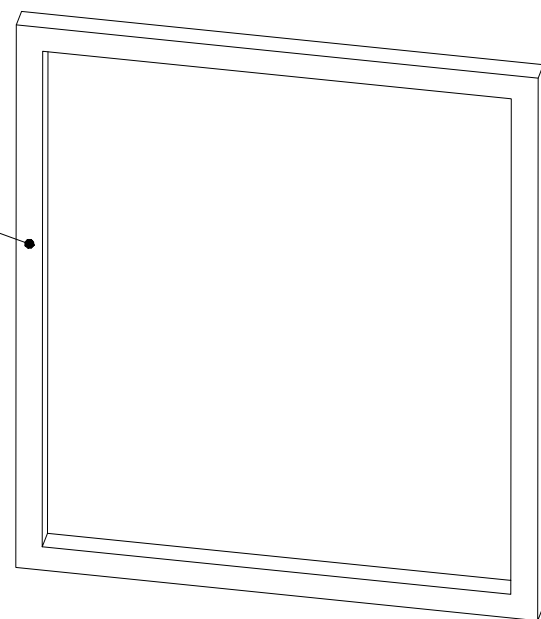

1

3

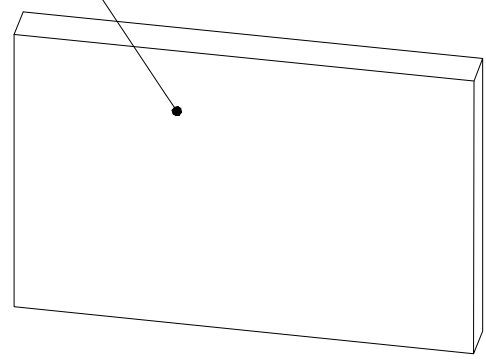

2

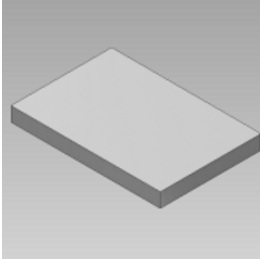
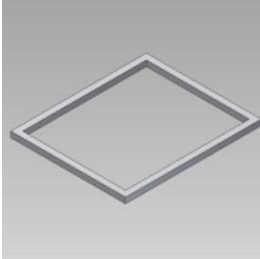

HOŘÁK 80KW SVAŘENEC+TĚSNĚNÍ +SIBREX	POZICE	POPIS	KÓD	ČÍSLO SOUČÁSTI	POČET KS	POZNÁMKY
	1	HOŘÁK 80KW - SVAŘENEC	PHXX8001	752.S00.000.A2	1	
	2	SIBREX 300 20x210x312	MTIZ0007		1	
	3	ŠŇŮRA TĚSNÍCÍ 18x18	MRUZ0133		1.54m	

PODAVAČ P2 EPO HOŘÁKU 80KW MK04

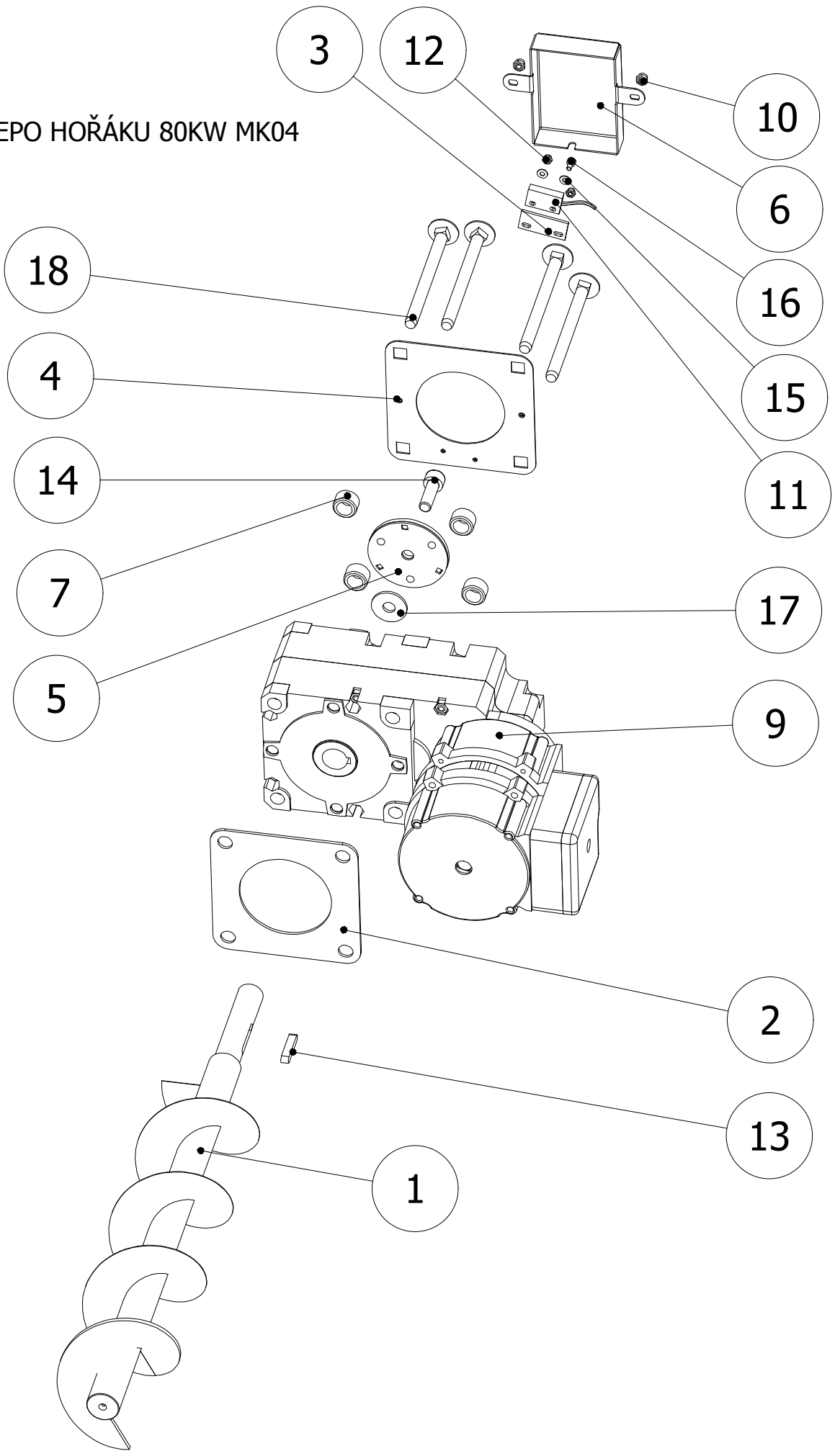





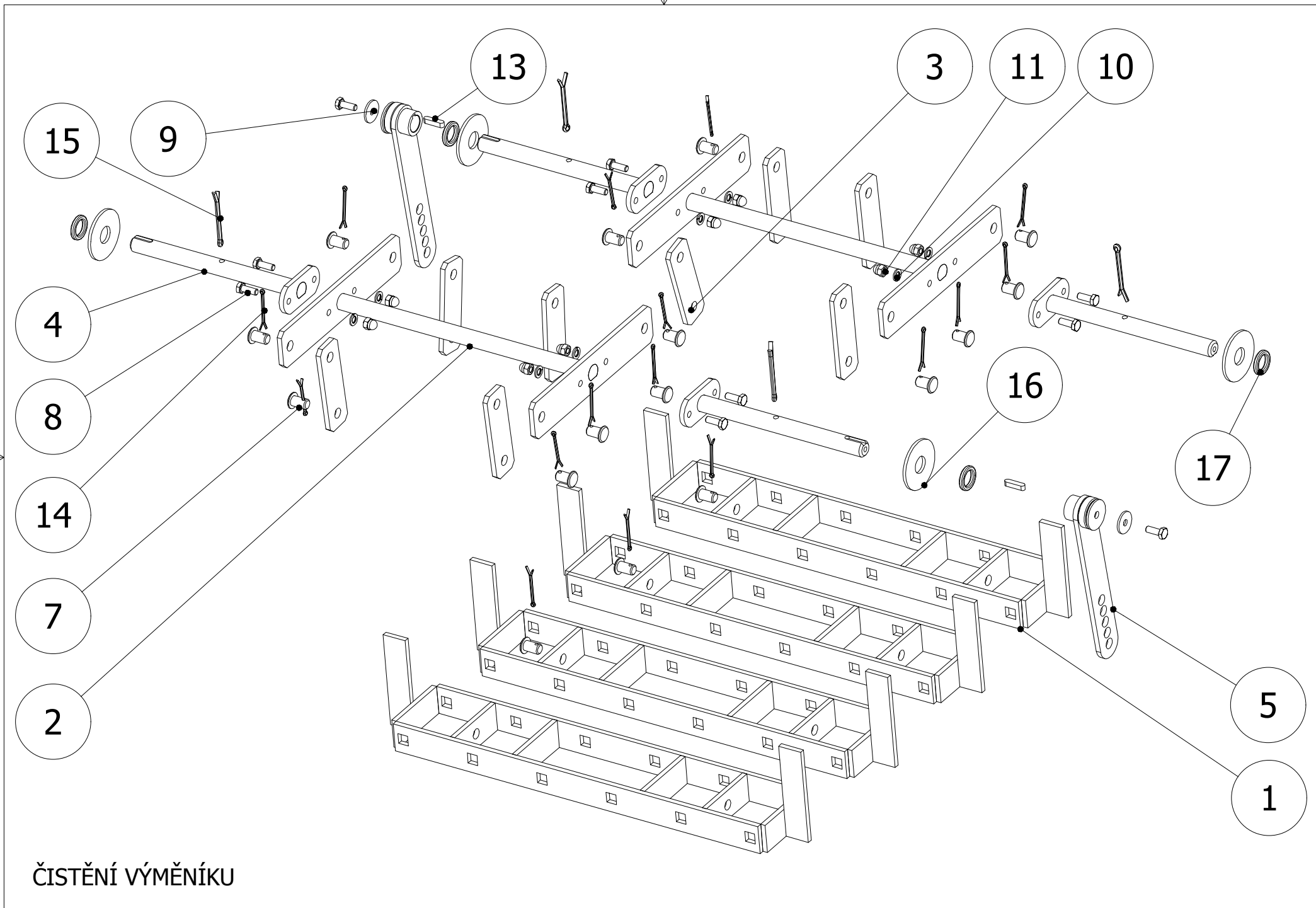

PODAVAČ P2 EPO HOŘÁKU KP80KW MK04	POZICE	POPIS	KÓD	ČÍSLO SOUČÁSTI	POZICE KS	POZNÁMKY
	1	ŠNEK KP62 PRO MOTOR ABM	PHXX0069	376.S15.000.A3	1	Délka 448mm
	2	MEZIKUS PRO ABM MOTORY	PHXX0161	601.000.000.A4	1	
	3	Adaptér pro MK04	PHXX0214	798.110.001.A4	1	
	4	DRŽÁK SNÍMAČE OTÁČEK	MHVH0119	428.100.000.A4	1	
	5	KOLO SNÍMAČE MEDER MK04/EPO	PHXX0213	PHXX0213	1	
	6	KRABIČKA SNÍMAČE SIGMATEK	MHVH0115	786.000.000.A4	1	

PODAVAČ P2 EPO HOŘÁKU KP80KW MK04	POZICE	POPIS	KÓD	ČÍSLO SOUČÁSTI	POZICE KS	POZNÁMKY
	7	DISTANCE DRŽÁKU SNÍMAČE	PHXX0162	428.400.000.A4	4	
	9	Motor EPO MRB 0,06kW/4p	MEMP0035		1	
	10	Šestihrná matice - M4	MSMX0026	DIN 985	2	
	11	Snímač MEDER MK04- 1A66-dl. 1900mm	MERX0777		1	
	12	Šestihrná matice pojistná - M3	MSMX0024	ISO 7040	2	
	13	Těsné pero - A 5 x 5 x 30	MSRX0007	DIN 6885	1	

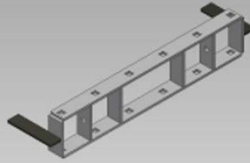

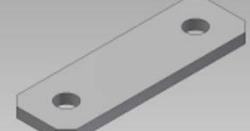
PODAVAČ P2 EPO HOŘÁKU KP80KW MK04	POZICE	POPIS	KÓD	ČÍSLO SOUČÁSTI	POZICE KS	POZNÁMKY
	14	Šroub s válcovou hlavou - M8 x 25	MSSX0095	DIN 912	1	
	15	Ploché podložky - 3	MSPX0031	ISO 7089	2	
	16	Šroub s válcovou hlavou - M3 x 6	MSSX0226	DIN 912	1	
	17	Podložka - 8,4	MSPX0008	DIN 9021	1	
	18	Šroub s půlk.hl.a 4rh.krčkem - M8 x 100	MSSX0129	DIN 603	4	



ČISTĚNÍ VÝMĚNÍKU

ČISTĚNÍ VÝMĚNÍKU KP82S	POZICE	POPIS	KÓD	ČÍSLO SOUČÁSTI	POČET KS	POZNÁMKY
	1	VAHADLO	PKTX0290	753.S01.000.A3	4	
	2	RAMENO KYVNÉ	PKTX0291	753.S02.000.A3	2	
	3	ZÁVĚS	PKTX0051	005.S16.004.A4	8	
	4	NÁSTAVEC	PKTX0389	797.S06.S00.A4	4	
	5	RAMENO	PKTX0163	445.S08.000.A4	2	
	7	ČEP	PKTX0053	005.S16.007.A4	16	

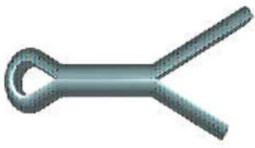
ČISTĚNÍ VÝMĚNÍKU KP82S	POZICE	POPIS	KÓD	ČÍSLO SOUČÁSTI	POČET KS	POZNÁMKY
	8	Šestihranný šroub - M6 x 16	MSSX0015	ISO 4017	10	Zn
	9	Podložka 6	MSPX0011	DIN 440R	2	
	10	Pružná podložka - A6	MSPX0019	DIN 128	8	
	11	Šestihranná matice uzavřená - M6	MSMX0027	DIN 1587	8	
	13	Těsné pero - A 5 x 5 x 22	MSRX0006	DIN 6885	2	
	14	Závlačka - 2,5 x 36	MSRX0048	ISO 1234	16	

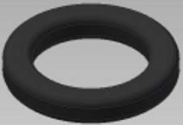

ČISTĚNÍ VÝMĚNÍKU KP82S	POZICE	POPIS	KÓD	ČÍSLO SOUČÁSTI	POČET KS	POZNÁMKY
	15	Závlačka - 4 x 50	MSRX0021	ISO 1234	4	
	16	Podložka - 17	MSPX0030	DIN 9021	4	
	17	Šňůra těs. čistění 4x4	PKTX0432		4	

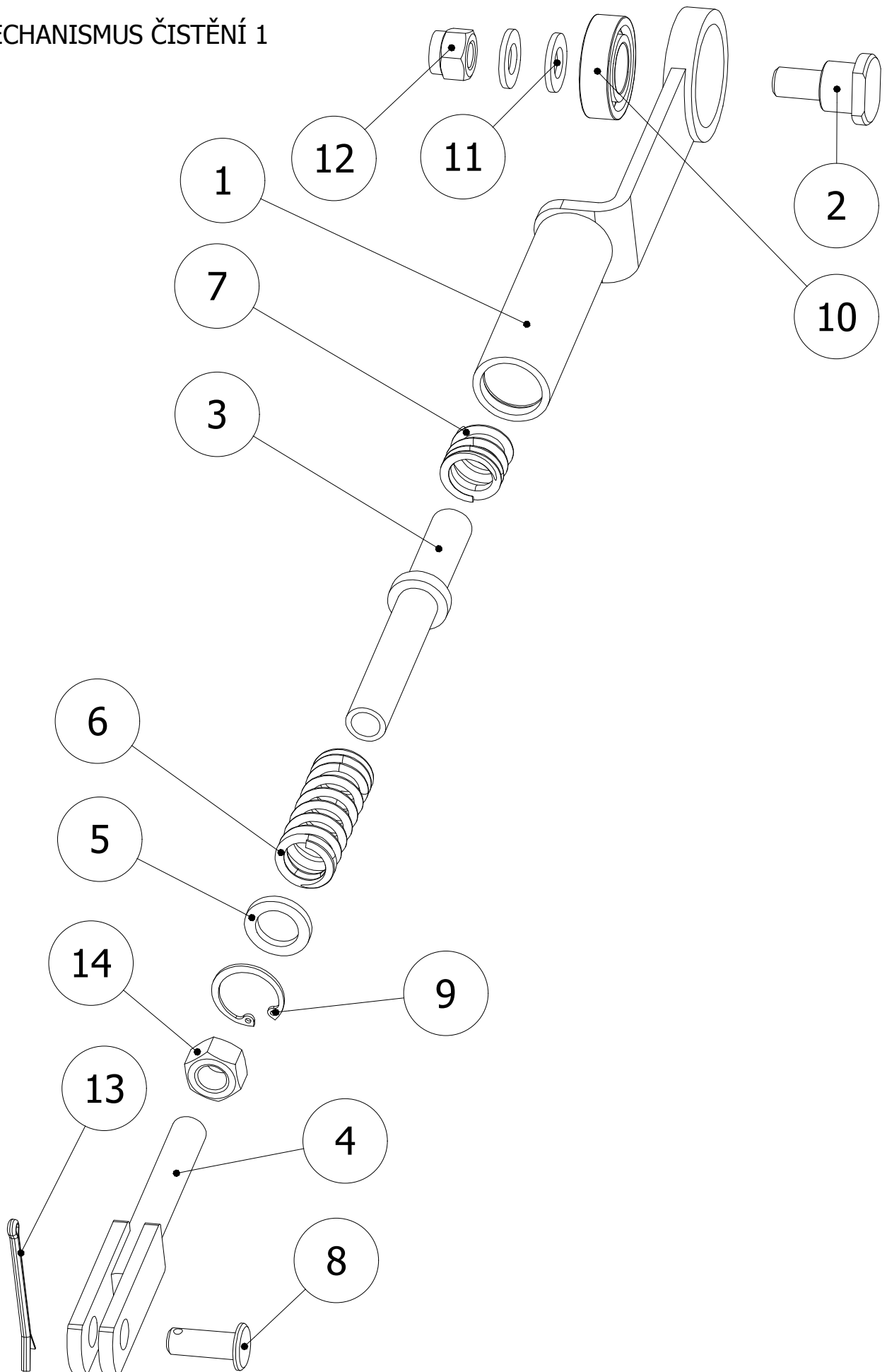
MECHANISMUS ČISTĚNÍ 1

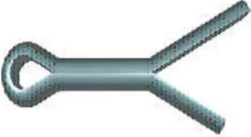

MECHANISMUS ČISTĚNÍ 1	POZICE	POPIS	KÓD	ČÍSLO SOUČÁSTI	POČET KS	POZNÁMKY
	1	ÓJE ČISTĚNÍ	PKTX0321	749.S10.S01.A4	1	
	2	ČEP	PKTX0176	424.010.000.A4	1	
	3	ČEP VEDENÍ	PKTX0324	749.S10.002.A4	1	
	4	VIDLICE	PKTX0171	424.S04.000.A4	1	
	5	VÍČKO	MHVT0139	424.005.000.A4	1	
	6	PRUŽINA TLAČNÁ	MRUZ0065	424.006.000.A4	1	

MECHANISMUS ČISTĚNÍ 1	POZICE	POPIS	KÓD	ČÍSLO SOUČÁSTI	POČET KS	POZNÁMKY
	7	PRUŽINA TLAČNÁ 2	PKTX0360	749.S10.007.A4	1	
	8	ČEP 1	PKTX0175	424.009.000.A4	1	
	9	Pojistné kroužky pro díry - 22	MSRX0014	CSN 02 2931	1	
	10	Kuličková ložiska jednořadá - 6003 2RS	MRUZ0048	CSN 02 4630	1	
	11	Ploché podložky - 10	MSPX0005	ISO 7089 - 10	2	
	12	Samojistné šestihranné matice - M10	MSMX0006	ISO 7041	1	

MECHANISMUS ČISTĚNÍ 1	POZICE	POPIS	KÓD	ČÍSLO SOUČÁSTI	POČET KS	POZNÁMKY
	13	Závlačka- 3,2 x 50	MSRX0059	ISO 1234	1	
	14	Šestihranné matice - M12	MSMX0007	ISO 4032	1	

MECHANISMUS ČISTĚNÍ 2

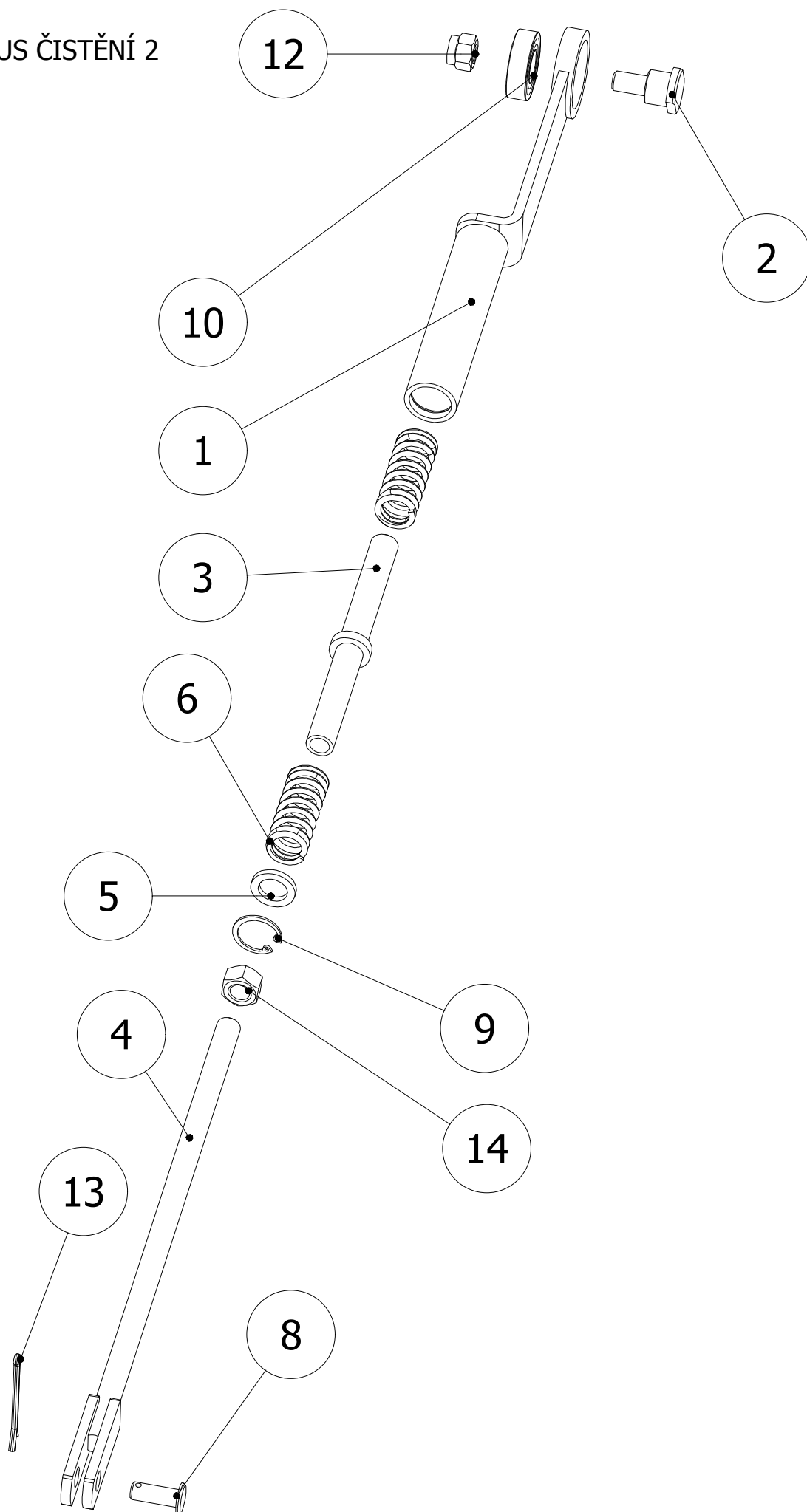

MECHANISMUS ČISTĚNÍ 2	POZICE	POPIS	KÓD	ČÍSLO SOUČÁSTI	POČET KS	POZNÁMKY
	1	ÓJE ČISTĚNÍ	PKTX0167	424.S01.000.A4	1	
	2	ČEP	PKTX0176	424.010.000.A4	1	
	3	ČEP VEDENÍ	PKTX0170	424.003.000.A4	1	
	4	VIDLICE	PKTX0319	749.S01.S02.A4	1	
	5	VÍČKO	MHVT0139	424.005.000.A4	1	
	6	PRUŽINA TLAČNÁ	MRUZ0065	424.006.000.A4	2	

MECHANISMUS ČISTĚNÍ 2	POZICE	POPIS	KÓD	ČÍSLO SOUČÁSTI	POČET KS	POZNÁMKY
	8	ČEP 1	PKTX0175	424.009.000.A4	1	
	9	Pojistné kroužky pro díry - 22	MSRX0014	CSN 02 2931	1	
	10	Kuličková ložiska jednořadá - 6003 2RS	MRUZ0048	CSN 02 4630	1	
	12	Samojistné šestihranné matice - M10	MSMX0006	ISO 7041	1	
	13	Závlačka- 3,2 x 50	MSRX0059	ISO 1234	1	
	14	Šestihranné matice - M12	MSMX0007	ISO 4032	1	

POHON ČISTĚNÍ

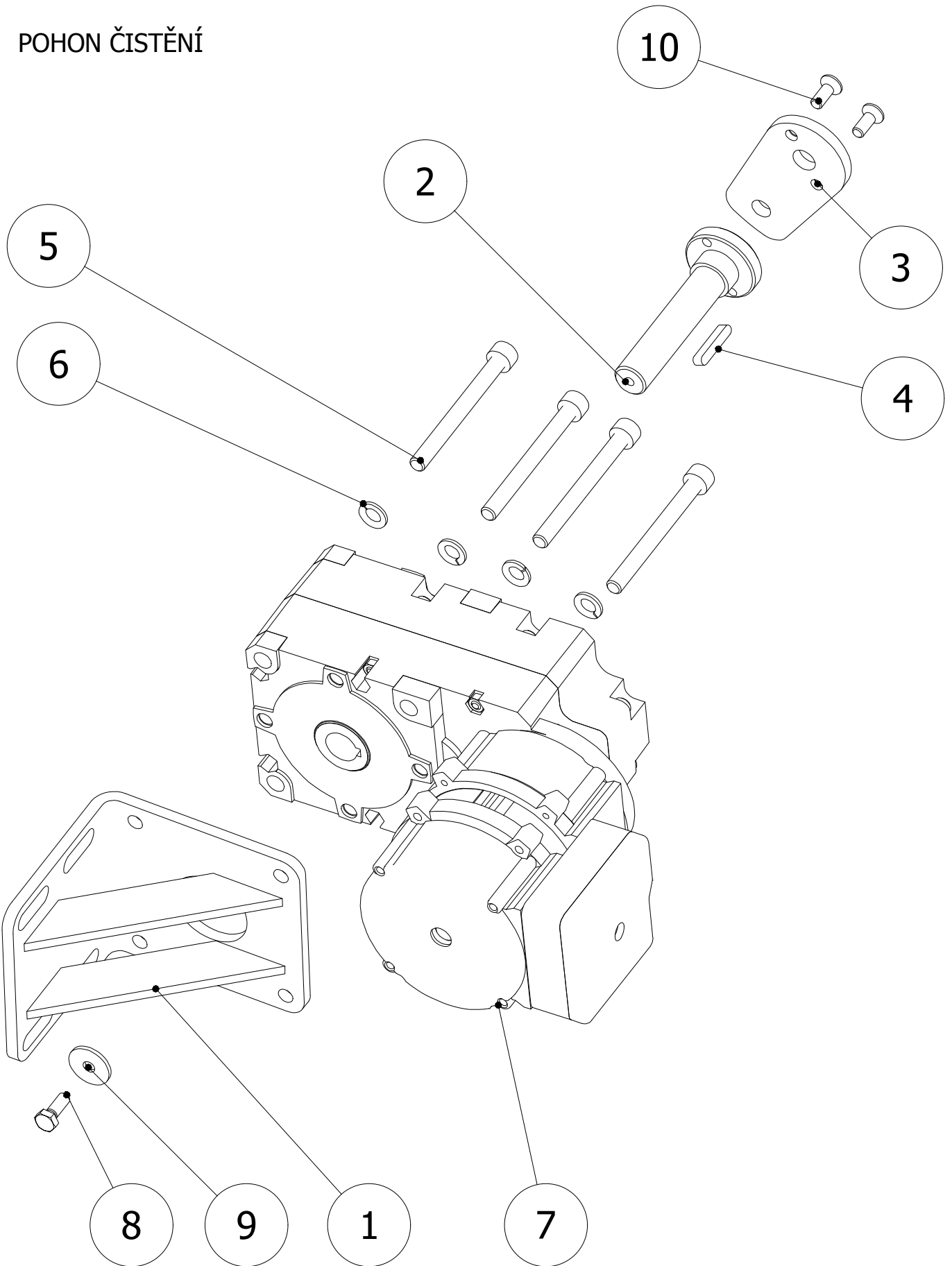

POHON ČISTĚNÍ TAHŮ	POZICE	POPIS	KÓD	ČÍSLO SOUČÁSTI	POČET KS	POZNÁMKY
	1	DRŽÁK MOTORU ABM	PKTX0216	446.S01.000.A3	1	
	2	UNAŠEČ	PKTX0218	446.002.000.A3	1	
	3	PÁKA	PKTX0179	397.S25.003.A4	1	
	4	Těsné pero - A 5 x 5 x 30	MSRX0007	DIN 6885	1	
	5	Šroub s válcovou hlavou - M8 x 80	MSSX0045	DIN 912	4	
	6	Pružná podložka - A8	MSPX0006	DIN 128	4	

POHON ČISTĚNÍ TAHŮ	POZICE	POPIS	KÓD	ČÍSLO SOUČÁSTI	POČET KS	POZNÁMKY
	7	Motor EPO MRB 0,12kW/2p	MEMP0037		1	
	8	Šestihranný šroub - M6 x 16	MSSX0015	DIN 933	1	
	9	Podložka 6	MSPX0002	DIN 440R	1	
	10	Šroub se zápustnou hlavou - M6 x 16	MSSX0096	DIN 7991	2	
	11	Kabel SIHF 3G 1	MEKV0003		1.5m	

POHON VYMETÁNÍ

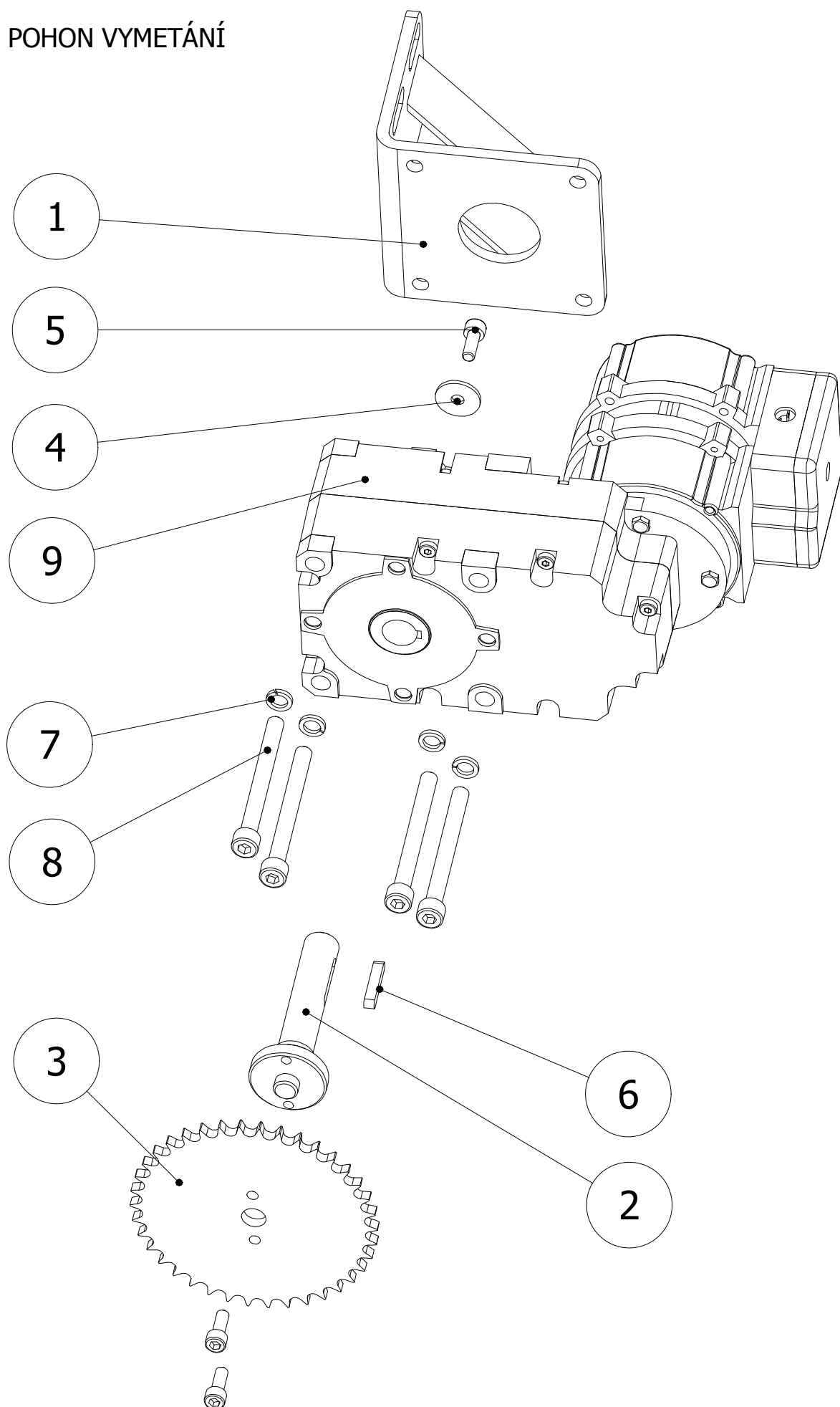

POHON VYMETÁNÍ KP82S	POZICE	POPIS	KÓD	ČÍSLO SOUČÁSTI	POČET KS	POZNÁMKY
	1	DRŽÁK MOTORU ABM	PKTX0216	446.S01.000.A3	1	
	2	UNAŠEČ	PKTX0218	446.002.000.A3	1	
	3	KOLO ŘETĚZOVÉ ÚPRAVA	PKTX0225	446.003.000.A4	1	
	4	Podložka 6	MSPX0011	DIN 440R	1	
	5	Šroub s válcovou hlavou - M6 x 16	MSSX0098	ISO 4762	3	
	6	Těsné pero - A 5 x 5 x 30	MSRX0007	DIN 6885	1	

POHON VYMETÁNÍ KP82S	POZICE	POPIS	KÓD	ČÍSLO SOUČÁSTI	POČET KS	POZNÁMKY
	7	Pružná podložka - 8	MSPX0006	DIN 7980	4	
	8	Šroub s válcovou hlavou - M8 x 80	MSSX0045	DIN 912	4	
	9	Motor EPO MRB 0,06kW/4p	MEMP0035		1	
	10	Článek spojovací jednoř.	MRUZ0041		1	
	11	Řetěz vál. jedn. 121 čl. 06 B-1 (3,8x7,32)	MRUZ0254		1	

ELEKTRO

KÓD	POPIS	MNOŽSTVÍ
MEKV0003	Kabel SIHF 3G 1	3,44 m
MEKV0006	Kabel H07 V-K 2.5 zž.	0,176 m
MEKV0007	Kabel SIHF 3x1.5	1,0 m
MEKV0011	Kabel H03VV-F 2x0,5	1,0 m
MEKV0027	Kabel H05VV-F 3G 1,5	1,0 m
MEKV0037	Kabel H07V-K 1,5 zž	3,0 m
MEKV0047	Šňůra FLEX H05VV-F 3x1,5 5m	1,0 ks
MEKV0054	Kabel CSSS 2Dx1/VO5SS-F/ silikon	1,0 m
MEKV0065	Kabel LiYY 4x0,14	5,0 m
MEKV0070	Kabel H05VV-F 4G1,5B	4,5 m
MEKV0071	Kabel H07V-K 1,5 sv.modr	2,5 m
MEKV0072	Kabel H07V-K 1,5 černý	3,0 m
MERX0003	Objímka plochá BF-F 608P	8,0 ks
MERX0004	Dutinka lis. DI 1.0-10 10	37,0 ks
MERX0016	Svorka WAGO 222-413	4,0 ks
MERX0020	Canon 9 V (RKP 12157)	1,0 ks
MERX0027	Trubička smršť. 3,2/1,6 SB/PBF-1/8	0,05 m
MERX0030	Objímka plochá RF-F 608P	3,0 ks
MERX0043	Canon sada matic CTB	1,0 ks
MERX0051	Vývodka PG 9 s matkou	16,0 ks
MERX0067	Přichytka PKB-BS 27x27mm přírodní samolepící	3,0 ks
MERX0073	Svorka WAGO 222-415	1,0 ks
MERX0078	Štítek uzemění malý /baleno po 40 ks/	4,0 ks
MERX0126	Oko lisovací RF-M4	6,0 ks
MERX0151	Spirála svazkovací SPC10	1,0 m
MERX0158	Pásek vázací 200/3,6	8,0 ks
MERX0205	Vývodka PG 7	9,0 ks
MERX0221	Kolík ploch.přístroj. SEZC7202-00/4/100	4,0 ks
MERX0237	Konektor RJ 45-8/8 C5 dr vidlice	1,0 ks
MERX0282	Konektor RJ 45-8 Cat.5e UTP	1,0 ks
MERX0529	Kolík dvojtý 7242-00/5/4	1,0 ks
MERX0581	Filtr odrušovací MIFLEX FP-250/16	1,0 ks
MERX0631	Konektor 2,5 / 3 green SIGMATEK	16,0 ks
MERX0632	Konektor 1,5 / 2 green SIGMATEK	15,0 ks
MERX0633	Konektor 2,5 / 2 green SIGMATEK	1,0 ks
MERX0634	Konektor 2,5 / 4 green SIGMATEK	4,0 ks
MERX0635	Konektor 1,5 / 4 green SIGMATEK	1,0 ks
MERX0636	Konektor 1,5 / 3 green SIGMATEK	1,0 ks
MERX0641	Kryt P - Canon 9	1,0 ks
MERX0648	Spirála svazkovací SPC15	0,5 m
MERX0661	Buž. smršť. SB 3,2/1,6 Mo modrá	0,06 m
MERX0662	Zástrčka ST18 -3 pol.č. Wieland	1,0 ks
METR0071	Deska základní HZS 521-G	1,0 ks
METR0072	Modul expandér HZS 532-1	1,0 ks
METR0083	Snímač teploty příložený KS 154A KTY 81-110, 3,5m	2,0 ks
METR0085	Snímač teploty TG8-55 KTY 81-110, 1,5m voda	1,0 ks
METR0087	Snímač teploty pro ven. KS 114B, KTY 81-110	1,0 ks

KÓD	POPIS	MNOŽSTVÍ
METR0108	Snímač teploty TR 050J-x TCK,silicon zelený 1,4m	1,0 ks
MREZ0012	Etiketa stříbrná 210x297	1,0 ks
MRUZ0211	FlashDisk USB 2,0 Sandisk Cruzer Fit 8GB	1,0 ks
MRUZ0219	Průchodka 24,9 x 1,6 Moss 11214	1,0 ks
MRUZ0220	Podložka tlum. 10x10x2,5 čtvercová 35604-0	5,0 ks
MRUZ0272	Zátka antivibrační 1/2 BSP - velikost 8	1,0 ks
MRUZ0274	Zátka souběžná 46.1MM č.465668	3,0 ks
MRUZ0275	Fólie laminovací A4	1,0 ks
MTBX0033	Páska oboustranně lepící š.=15mm	0,02 ks
PKEX0020	Rozvodnice zapalování KP 62S/82S	1,0 ks
PKEX0039	Kabeláž KP 82S - 2,7 m SIGMATEK	1,0 ks

PONAST spol. s r.o
Na Potůčkách 163
757 01 Valašské Meziříčí

ČESKÁ REPUBLIKA

www.ponast.cz

tel.: 571 688 111*, 800 700 068

e-mail: servis@ponast.cz